

# Deliver High Quality, High Performance HEVC via Intel® Media Server Studio

## A white paper unlocking new video technology opportunities

HEVC is an exciting, cutting edge, highly efficient, new video compression technology enabling next generation of digital media applications, products and services. Intel is at the forefront of this development, leading the HEVC technology revolution. Intel® Media Server Studio 2018 offers industry leading, among the best in class developer focused HEVC solutions that offer an excellent tradeoff of quality versus performance. This white paper introduces updated capabilities of Intel's developer focused HEVC product offering, the Intel® Media Server Studio HEVC Encoder and Decoder. This R1 release incorporates intelligent technologies that improve objective and subjective quality of coded video, as well as features to improve its usability. To improve subjective quality, content adaptive partitioning and mode decision, as well as content, human visual system, and persistence based quantization are now employed. To improve usability, there is (1) support for live encoding in terms of latency and quality, (2) improved quality for interlaced video coding, (3) support for multiple BRC modes such as CBR, VBR, and AVBR, and, (4) streamlined quality measurement for 1080p 8-bit, and 4K 10-bit coded video based both on PSNR, and MS-SSIM to be closer to subjective basis, and, (5) performance measurement on recent Intel® core platforms. Thus, this latest offering supports a wide range of applications, services, eco-systems, and devices.

May 16 2018, v2.0

Author: Atul Puri

## LEGAL DISCLAIMER

The benchmark results reported may need to be revised as additional testing is conducted. The results depend on the specific platform configurations and workloads utilized in the testing, and may not be applicable to any particular user's components, computer system or workloads. The results are not necessarily representative of other benchmarks and other benchmark results may show greater or lesser impact from mitigations.

Software and workloads used in performance tests may have been optimized for performance only on Intel microprocessors. Performance tests, such as SYSmark and MobileMark, are measured using specific computer systems, components, software, operations and functions. Any change to any of those factors may cause the results to vary. You should consult other information and performance tests to assist you in fully evaluating your contemplated purchases, including the performance of that product when combined with other products. For more complete information visit [www.intel.com/benchmarks](http://www.intel.com/benchmarks).

INFORMATION IN THIS DOCUMENT IS PROVIDED IN CONNECTION WITH INTEL PRODUCTS. NO LICENSE, EXPRESS OR IMPLIED, BY ESTOPPEL OR OTHERWISE, TO ANY INTELLECTUAL PROPERTY RIGHTS IS GRANTED BY THIS DOCUMENT. EXCEPT AS PROVIDED IN INTEL'S TERMS AND CONDITIONS OF SALE FOR SUCH PRODUCTS, INTEL ASSUMES NO LIABILITY WHATSOEVER AND INTEL DISCLAIMS ANY EXPRESS OR IMPLIED WARRANTY, RELATING TO SALE AND/OR USE OF INTEL PRODUCTS INCLUDING LIABILITY OR WARRANTIES RELATING TO FITNESS FOR A PARTICULAR PURPOSE, MERCHANTABILITY, OR INFRINGEMENT OF ANY PATENT, COPYRIGHT OR OTHER INTELLECTUAL PROPERTY RIGHT.

Intel may make changes to specifications and product descriptions at any time, without notice. Designers must not rely on the absence or characteristics of any features or instructions marked "reserved" or "undefined." Intel reserves these for future definition and shall have no responsibility whatsoever for conflicts or incompatibilities arising from future changes to them. The information here is subject to change without notice. Do not finalize a design with this information.

The products described in this document may contain design defects or errors known as errata which may cause the product to deviate from published specifications. Current characterized errata are available on request.

MPEG is an international standard for video compression/decompression promoted by ISO. Implementations of MPEG CODECs, or MPEG enabled platforms may require licenses from various entities, including Intel Corporation.

**Optimization Notice:** Intel's compilers may or may not optimize to the same degree for non-Intel microprocessors for optimizations that are not unique to Intel microprocessors. These optimizations include SSE2, SSE3, and SSE3 instruction sets and other optimizations. Intel does not guarantee the availability, functionality, or effectiveness of any optimization on microprocessors not manufactured by Intel. Microprocessor-dependent optimizations in this product are intended for use with Intel microprocessors. Certain optimizations, not specific to Intel microarchitecture, are reserved for Intel microprocessors. Please refer to the applicable product User and Reference Guides for more information regarding the specific instruction sets covered by this notice. Notice revision #20110804

\*Other names and brands may be claimed as property of others.

Intel, the Intel logo, Intel Core are trademarks or registered trademarks of Intel Corporation or its subsidiaries in the United States and other countries.

OpenCL and the OpenCL logo are trademarks of Apple Inc. used by permission by Khronos.

Copyright © Intel Corporation. All Rights reserved.

## ACKNOWLEDGEMENT

The author would like to acknowledge contributions (test data, some graphics) of his colleagues Sebastian Possos and Dmitry Kozlov to this white paper.

## Table of Contents

ACKNOWLEDGEMENT.....	2
<b>Introduction .....</b>	<b>5</b>
<b>HEVC Compression Basics .....</b>	<b>6</b>
HEVC Data Hierarchy .....	6
HEVC Partitioning, Prediction and Coding Technologies .....	7
Coding Tree Unit/Block (CTU/CTB) .....	7
Coding Unit (CU).....	7
Prediction Unit (PU).....	8
Transform Unit (TU).....	8
Intra Coded PU .....	9
Inter Coded PU .....	9
Motion Merge.....	10
Transforms.....	10
Interpolation Filter .....	11
Deblock Filtering.....	11
Sample Adaptive Offset (SAO) .....	12
HEVC Encoder .....	12
<b>Intel® Media Server Studio Overview.....</b>	<b>13</b>
<b>Intel® Media SDK stack, and HEVC Encoder Plugin Architecture .....</b>	<b>15</b>
<b>Recent additions to Intel® Media Server Studio/MSDK 2018 R1 HEVC Encoders .....</b>	<b>16</b>
<b>Intel® Media Server Studio HEVC Software, and GAcc Encoders Quality Evaluation for HD1080p 8-bit video content.....</b>	<b>18</b>
Quality Evaluation Test Methodology for HD1080p 8-bit .....	18
Quality Evaluation Test Set, Configurations and Parameters for HD1080p 8-bit.....	19
Results of Quality Evaluation Tests for HD1080p 8-bit.....	21
Intel® MSS HEVC Encoder Quality vs Performance for HD1080p 8-bit .....	41
Performance on cfg1 of MSS HEVC Software, and GAcc Encoders on HD1080p 8-bit .....	42
Performance on cfg2 of MSS HEVC Software, and GAcc Encoders on HD1080p 8-bit.....	43
Performance on cfg3 of MSS HEVC Software, and GAcc Encoders on HD1080p 8-bit.....	44
Performance on cfg4 of MSS HEVC Software, and GAcc Encoders on HD1080p 8-bit.....	45
Encoding Speed comparison for different cfg's, and TU settings for HD1080p 8-bit .....	46

\*Other names and brands may be claimed as property of others.

CPU Load Comparison of MSS HEVC Software, and GAcc Encoders on HD1080p 8-bit .....	48
Quality vs Performance of MSS HEVC Software, and GAcc Encoders on HD1080p 8-bit.....	50
Intel® MSS HEVC Software Decoder Performance for HD1080p 8-bit .....	52
<b>Intel® Media Server Studio HEVC Software, and GAcc Encoders Quality Evaluation for UHD4K 10-bit video content .....</b>	<b>56</b>
Quality Evaluation Test Methodology for UHD4K 10-bit.....	56
Quality Evaluation Test Set, Configurations and Parameters for UHD4K 10-bit.....	57
Results of Quality Evaluation Tests for UHD4K 10-bit.....	59
Intel® MSS HEVC Encoder Quality vs Performance for UHD4K 10-bit.....	79
Performance on cfg3 of MSS HEVC Software, and GAcc Encoders on UHD4K 10-bit .....	80
Performance on cfg4 of MSS HEVC Software, and GAcc Encoders on UHD4K 10-bit .....	81
Encoding Speed comparison for different cfg’s, and TU settings for UHD4K 10-bit.....	82
CPU Load Comparison of MSS HEVC Software, and GAcc Encoders on UHD4K 10-bit.....	84
Quality vs Performance Tradeoff of MSS HEVC Software, and GAcc Encoders for UHD4K 10-bit .....	86
Intel® MSS HEVC Software Decoder Performance for UHD4K 10-bit.....	88
<b>Summary .....</b>	<b>90</b>
<b>References .....</b>	<b>91</b>
<b>Appendix A.....</b>	<b>92</b>
Summary of Quality and Performance on HD1080p 8-bit content.....	92
<b>Appendix B.....</b>	<b>94</b>
Summary of Quality and Performance on UHD4K 10-bit content .....	94

# Deliver High Quality, High Performance HEVC via Intel® Media Server Studio

A white paper unlocking new video technology opportunities

## Introduction

HEVC (aka, H.265) [1-4] is a new, highly efficient, video compression standard from ISO MPEG that promises substantially higher compression over H.264 (aka, AVC) [4,6], its previous generation standard completed around 10 years ago. In particular HEVC promises roughly a factor of 2 in compression over H.264, that had delivered a factor of 2 in compression over MPEG-2, its earlier generation standard. H.264 is currently dominant having supplemented or displaced MPEG-2 in nearly all digital video applications, services, products, and eco-systems. Over next few years the time seems ripe for HEVC due to its advantages, to supplement or displace H.264 in the same manner. Overall MPEG has an excellent history [4] of delivering on video standards that have a wide industry following.

Intel® Media Server Studio SDK (formerly, Media SDK) is a well-known developer product that implements state of art standards based highly optimized decoders, corresponding efficient and highly optimized encoders, file/stream formatting, and pre- and postprocessing tools supporting efficient coding. Intel® Media Server Studio SDK implements many Codec and tools components initially in software, and later as hybrid (of software and hardware) or entirely in hardware. The reason for this multi-tier approach is faster time to market for software solutions, followed by hybrid solutions that contains partial hardware acceleration, and lastly blazingly fast hardware solutions that scale. Intel® Media Server Studio SDK 2018 is available both for Windows and Linux. It supports Intel® 6<sup>th</sup> through 8<sup>th</sup> generation Core™ and Xeon® Processor based platforms with Intel Graphics.

Intel® Media Server Studio 2018 is just being released and includes a number of significant tools, technologies, and enhancements (<https://software.intel.com/en-us/intel-media-server-studio-support/documentation>) including improved software implementation of HEVC Encoders and Decoders. Since not all HEVC implementations are created equal, this white paper attempts to quantify the quality and performance a developer should expect from Intel® Media Server Studio HEVC Codec software implementation. Rest of the white paper is organized as per following sections.

- HEVC Compression Basics
- Intel® Media Server Studio Overview
- Intel® Media Server Studio HEVC R1 release (Codec Quality, Encoder Quality vs Performance Tradeoffs, and Decoder Performance) results presented in 2 parts as follows.
  - Part 1: HD 1080p 8-bit Coding Quality evaluation, and detailed Performance Tests
  - Part 2: UHD4K 10-bit Coding Quality evaluation, and detailed Performance Tests
- Appendix A and B summarize overall quality & performance results.

\*Other names and brands may be claimed as property of others.

## HEVC Compression Basics

HEVC builds on the well-known classical interframe coding framework of block motion compensated transform coding. However unlike previous MPEG/ITU-T standards including H.264 instead of using smaller, fixed size processing based on macroblocks and blocks for motion compensated prediction and small block transform coding, it uses larger, flexible structures that are partitioned for motion compensated prediction, and a range of large to small block sizes for transform coding. There are other significant difference as well.

### HEVC Data Hierarchy

Fig. 1 shows high level data structure hierarchy. The terms Video, GOP and Picture as shown are only conceptual while Slices and lower layers are actual layers employed by HEVC.

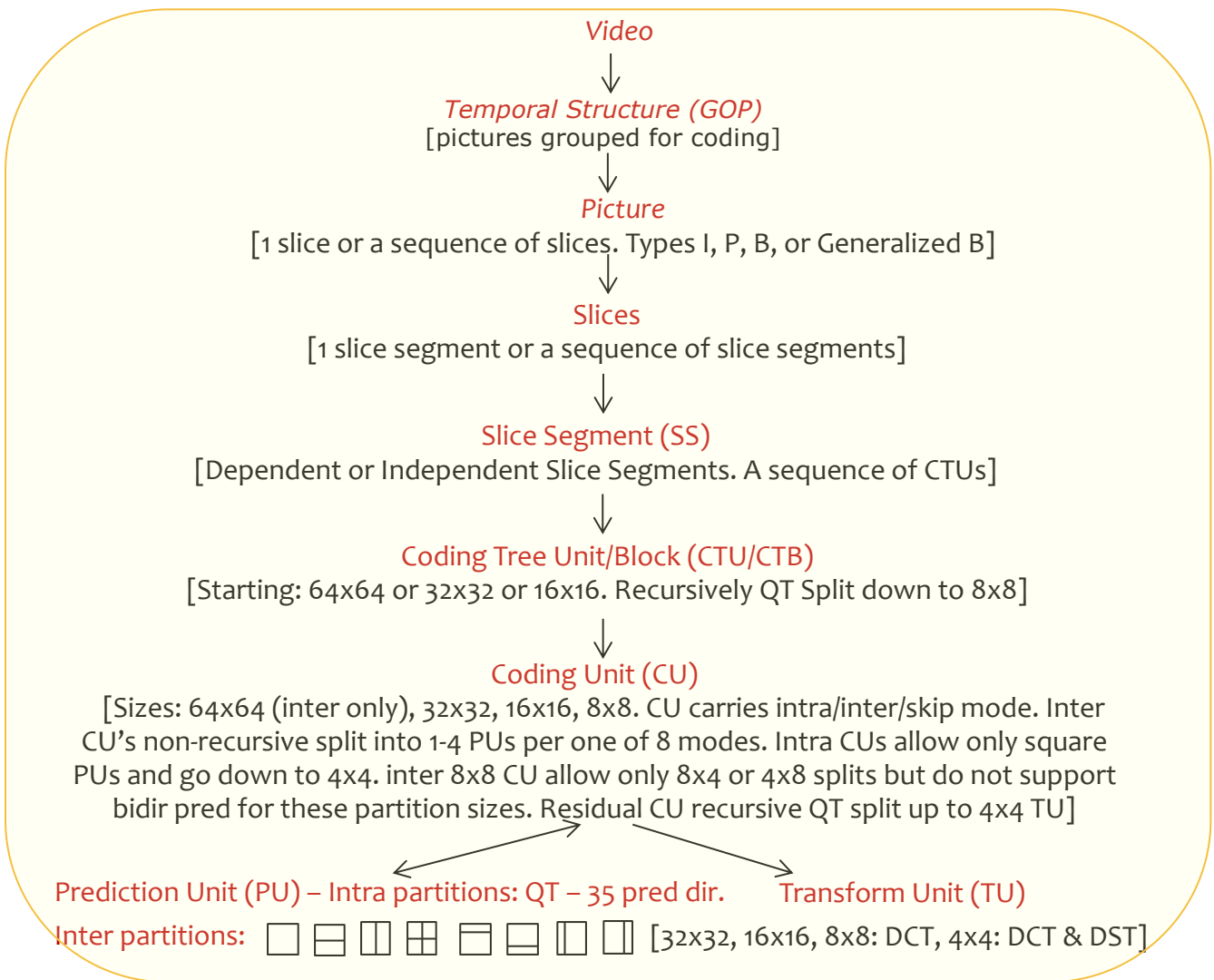

Figure 1 HEVC data hierarchy. Video, GOP & Pictures are conceptual, others are actual layers.

## HEVC Partitioning, Prediction and Coding Technologies

We now introduce the significant components of HEVC processing structures as well as discuss actual video coding algorithms. Due to significant amount of details only high level concepts are covered. Further, a 2 column visual presentation style is used that shows for each topic, a key concept shown in the first column and a related illustration in the second column showing. Since this section is a brief overview of the standard, the concepts are simplified and not necessarily covered in extreme detail.

### Coding Tree Unit/Block (CTU/CTB)

- Defined at a high level
- A CTU consists of 3 CTBs (1 luma plus 2 chroma)
- Luma CTB starting size one of
  - 64x64
  - 32x32
  - 16x16
- Corresponding Chroma CTB, half in size horizontally and vertically
- Luma CTB split by recursive QuadTree down to 8x8

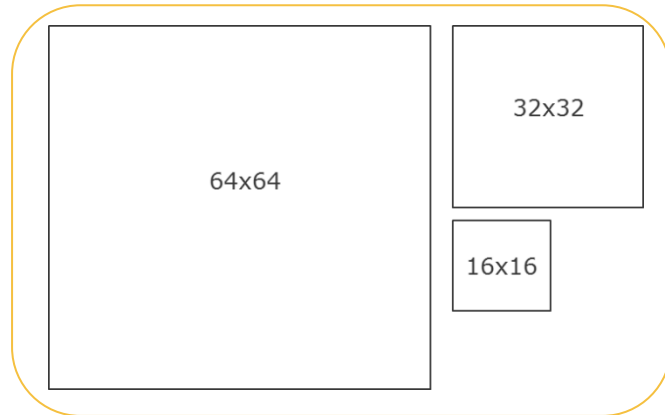

Figure 2A Luma CTB starting size options

### Coding Unit (CU)

- Always Square
  - Largest CU (LCU) as big as size of luma CTB
  - As small as 8x8
  - Sizes: 64x64, 32x32, 16x16, 8x8
- Traversed in Zig-zag order
- Types: Intra, Inter, Skip
- Intra CU
  - Largest size 32x32
  - Partitioned in to square Prediction Units (PU) up to 4x4
- Inter CU
  - Largest size 64x64
  - 8x8 CU partitioned into 8x4, and 4x8 PUs only; no bidirectional pred

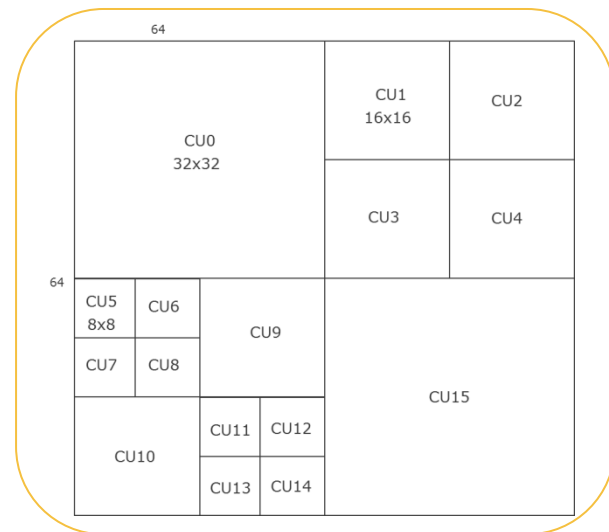

Figure 2B Partitioning of a luma CTU into CUs



### Prediction Unit (PU)

- CU partitioning into Prediction partitions is nonrecursive
- Intra CUs partitioned into square Prediction partitions
  - 32x32
  - 16x16
  - 8x8
  - 4x4
- Inter CU (64x64, 32x32, 16x16, 8x8) partitioned into 1 of 8 Prediction partition modes
  - Partitioned into 1, 2, or 4 partitions
  - 8x8 PU is partitioned into 8x4, 4x8 only; also no bidirectional prediction mode for 8x8 PUs
- Using PU partitions, a residual CU is constructed prior to coding

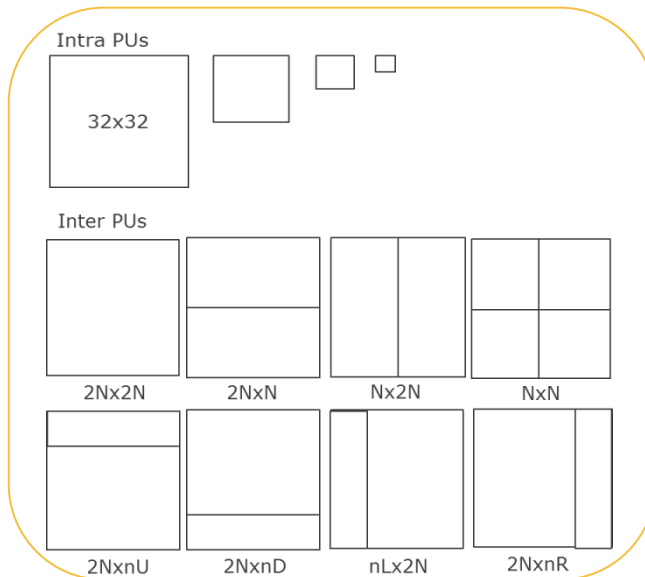

Figure 2C Intra and Inter PU examples

### Transform Unit (TU)

- Residual CU, QuadTree recursively split into TUs
- TUs of following sizes (no 64x64 TU)
  - 32x32
  - 16x16
  - 8x8
  - 4x4
- Chroma TU of 1/4 th size of luma TU but smallest TU for chroma is 4x4 (no 2x2 TUs for chroma)
- TU of size 4x4 flagged by coded/not coded
- DCT Transform on all TU sizes (32x32, 16x16, 8x8, 4x4)
- DST Transform on size 4x4 TU

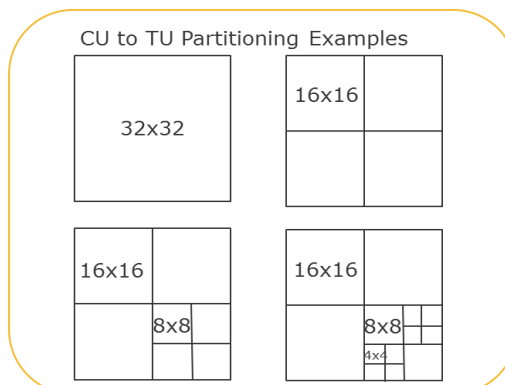

Figure 2D Partitioning of a CU into TUs

### Intra Coded PU

- Each Intra Coded PU
  - Pred mode for Luma
  - Pred mode for Chroma
- All TUs in a PU use the same mode
- For Luma candidate choices for prediction mode
  - Planar
  - DC
  - 33 Angular Pred Directions
- For Chroma candidate choices for prediction mode
  - Planar
  - DC
  - Hor
  - Vert
  - Luma pred mode copy

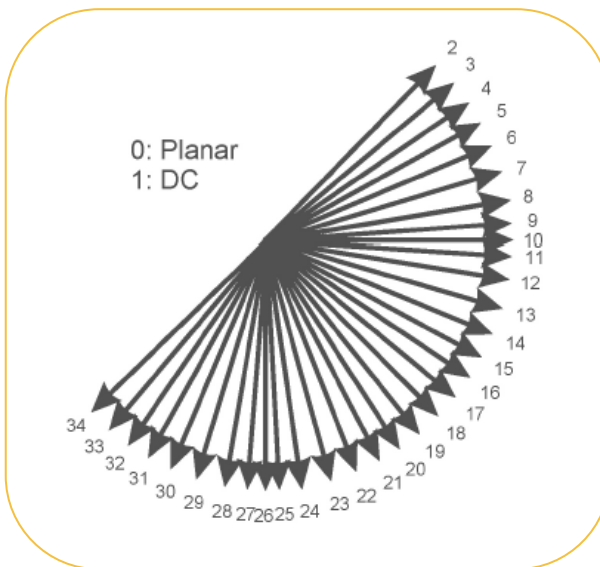

Figure 2E Intra Luma prediction directions

### Inter Coded PU

- Motion Pars specified explicitly or implicitly
  - Motion vector
  - Ref Picture Index
  - Picture List Usage Flag
- For inter coded CU with PredMode=Skip, CU coded with no transform coeff, or motion vector, and ref picture flag, and ref picture list usage obtained by motion merge.
- For inter coded CU with PredMode=Inter, either use Motion merge or explicit motion pars

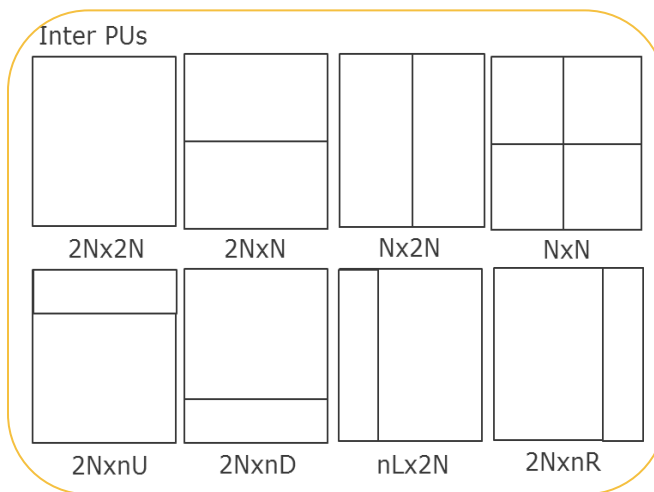

Figure 2F Inter Coded PU Partitionings

\*Other names and brands may be claimed as property of others.

### Motion Merge

- Spatial Merge Candidates
  - 5 positions
  - Select 4 Candidates
  - Remove Partition Redundancy
- Temporal Merge Candidates
  - 2 positions
  - Select 1 candidate
- Merge Process
  - Remove duplicates from Spatial and Temporal Candidates
  - Add combined bi-predictive candidates
  - Add nonscaled bi-predictive candidates
  - Add zero merge candidates
  - Final merge candidates

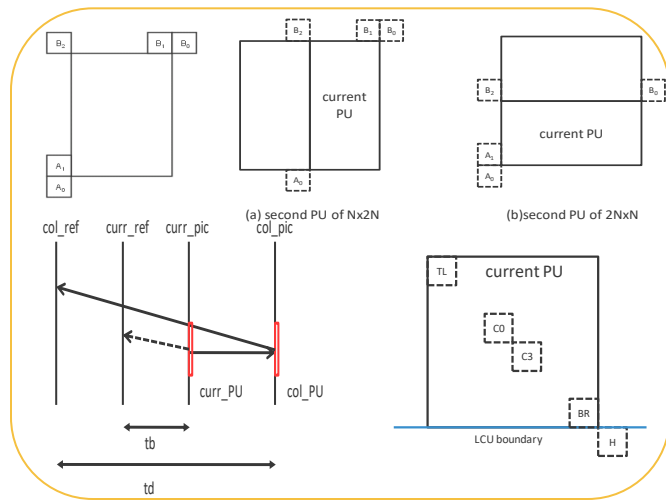

Figure 3A Spatial Merge candidates position, position of second PU of Nx2N, and 2NxN, MV scaling of temporal merge, coding of spatial merge, Temporal Merge candidates C3 and H

### Transforms

- 4x4 integer DST approx. Size 4 basis matrix shown on right.
- 4x4 integer DCT approx. Size 4 basis matrix shown on right.
- 8x8 integer DCT approx. Size 8 basis matrix shown on right.
- 16x16 integer DCT approx. Size 16 basis matrix shown on right.

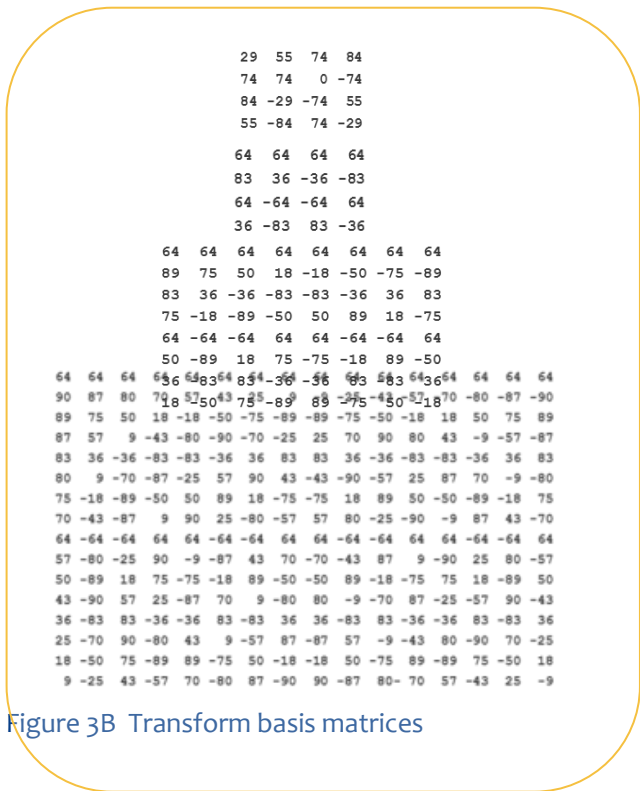

Figure 3B Transform basis matrices

- 32x32 ineger DCT approx. Size 32 basis matrix not shown.

### Interpolation Filter

- Luma
  - 1/4 pel interpolation
  - 7/8 tap filter
  
- Chroma
  - 1/8 pel interpolation
  - 4 tap filter

Position	Filter coefficients
1/4	-1, 4, -10, 58, 17, -5, 1
2/4	-1, 4, -11, 40, 40, -11, 4, -1
3/4	1, -5, 17, 58, -10, 4, -1

Position	Filter coefficients
1/8	-2, 58, 10, -2
2/8	-4, 54, 16, -2
3/8	-6, 46, 28, -4
4/8	-4, 36, 36, -4
5/8	-4, 28, 46, -6
6/8	-2, 16, 54, -4
7/8	-2, 10, 58, -2

Figure 3C 4-tap DCT/IF Luma Filter, and 8 tap

### Deblock Filtering

- Overall Process
  - Boundary strength calculation
    - Based on if P or Q is intra, P or Q has nonzero coef, Pand Q have different ref, P and Q have different num of MVs..
    - 3 levels of strength 0, 1, 2
  - Threshold value  $\beta$  and  $T_c$  calculation from input Q
- Filter on/off Decision

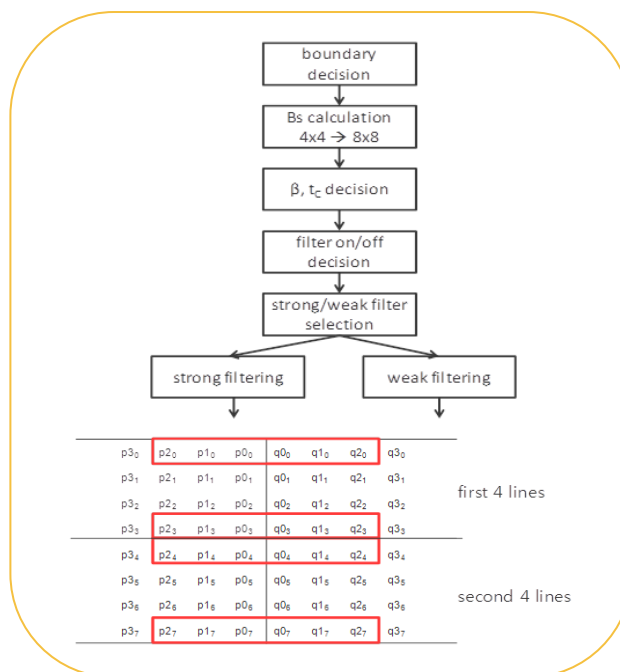

Figure 3D Deblock filtering in HEVC

\*Other names and brands may be claimed as property of others.

## Sample Adaptive Offset (SAO)

- Applied to reconstructed video
- SAO Types
- Details of how SAO Types work
  - 3 pel patterns for pixel classification in Edge Offset
  - Pixel Classification Rules for Edge Offset
  - Grouping 4 bands and Representation

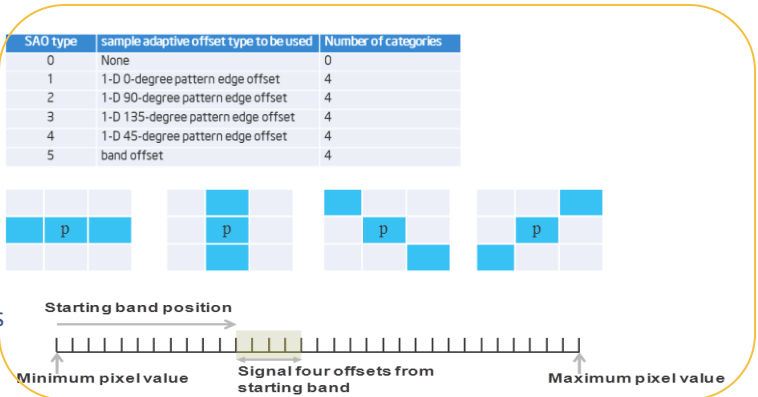

Figure 3E Sample Adaptive Offset Types, Edge Classification, and Grouping of Bands

## HEVC Encoder

Fig. 4 shows high level block diagram of HEVC Encoder. Input video frames are partitioned recursively from CTB's to CUs and then nonrecursively into PUs. The prediction partition PUs are then combined to generate Prediction CUs that are differenced from the original resulting in residual CU's that are recursively QT split into TUs and coded with variable Block Size (VBS) transform of 4x4 (DST or DCT approx), or 8x8, 16x16, and 32x32 (DCT approx only). CU/PU Partitioner partitions into CU/PU, and the TU partitioner partitions into TUs. An Encode Controller controls the degree of partitioning performed which depends on quantizer used in transform coding. The CU/PU Assembler and TU Assembler perform the reverse function of partitioner. The decoded (every DPCM encoder incorporates a decoder loop) intra/motion compensated difference partitions are assembled following inverse DST/DCT to which prediction PUs are added and reconstructed signal then Deblock, and SAO Filtered that correspondingly reduce appearance of artifacts and restore edges impacted by coding.

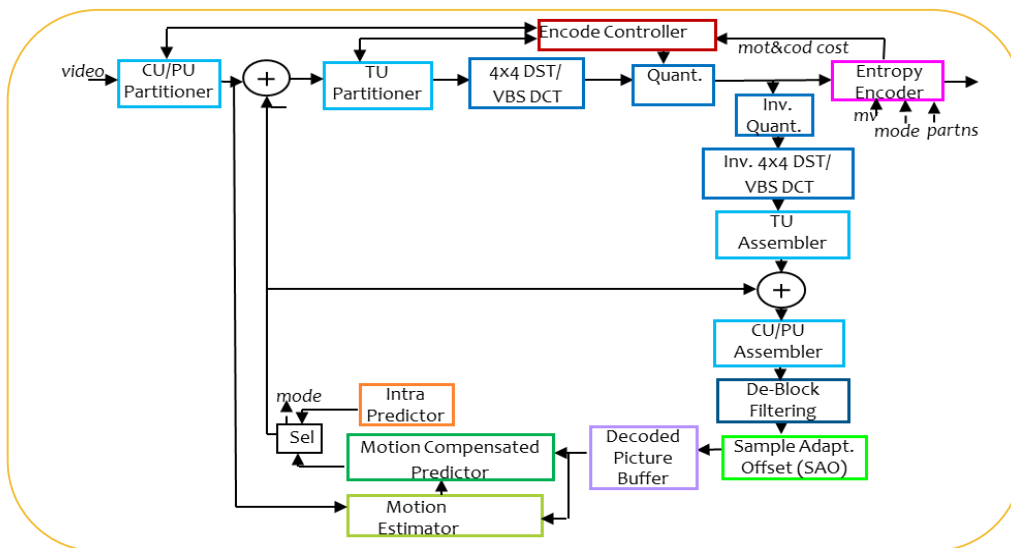

Figure 4 HEVC Encoder

## Intel® Media Server Studio Overview

Intel® Media Server 2018 provides innovative technologies and optimized tools to deliver efficient video solutions for data-center, cloud, and network use-cases.

It can enable not only traditional applications but also high quality real-time video transcode for:

- Broadcasting
- Over the top (OTT) live and video on demand
- Cloud gaming
- Remote desktop

Intel® now offers the following two flavors of media tool kits, this years' versions of which are as follows.

- Intel® Media Server Studio 2018 (Linux)
- Intel® Media SDK 2018 for Windows®

Both of the above toolkits are currently in their R1 edition for 2018 and thus are referred to respectively as Intel® Media Server Studio 2018 R1, and Intel® Media SDK 2018 R1. These toolkits allow optimization of video solutions from camera all the way to the cloud. The MSS 2018 suite runs on Linux while MSDK 2018 suite runs on Windows®.

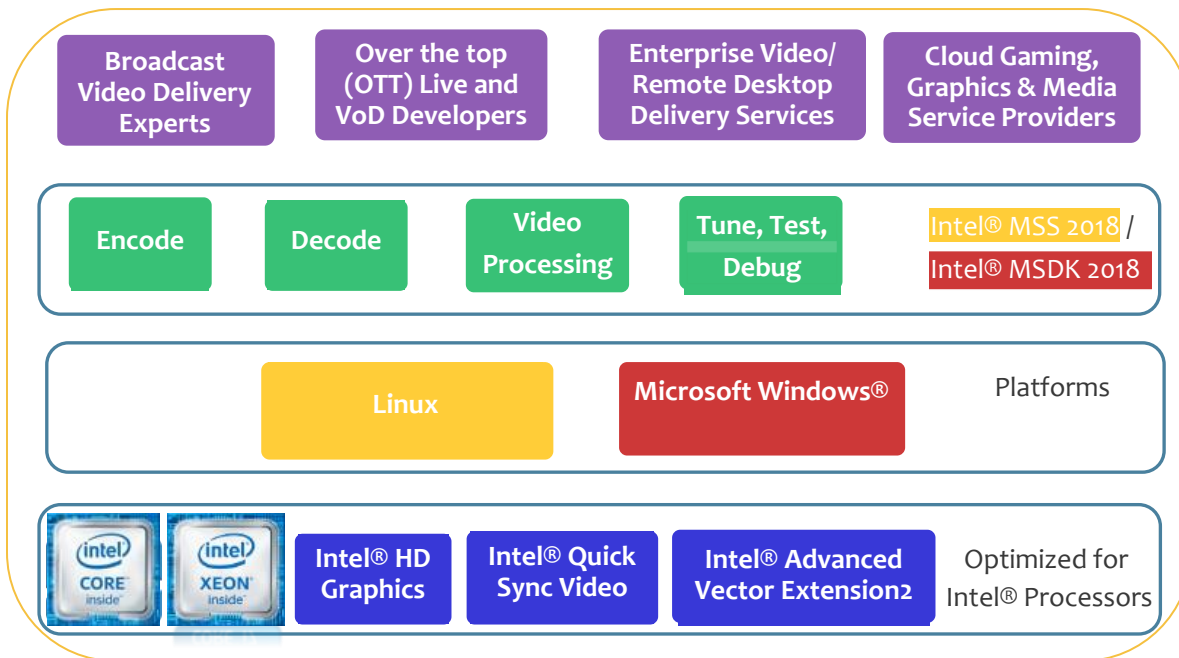

Figure 5A A high level view of Intel® Media Server Studio 2018/Intel® Media SDK 2018

The Intel® Media Server Studio (MSS) 2018 suite provides high performance software development tools, libraries, and infrastructure needed to help create, develop, debug, test, and deploy next generation enterprise grade media solutions on Intel® server processors and graphics.

\*Other names and brands may be claimed as property of others.

The suite is offered appropriately segmented into bundles in order to offer maximum flexibility, cost advantage, and convenience to software developers, data center solutions providers, and OEMs to enable faster time to market.

The Intel® Media Server Studio Essentials/Community Edition of the suite refers to a basic bundle of features. The Community Edition that is free, now not only includes all the features of community edition of 2017 but also now includes optimized HEVC Software, and HEVC Graphics Accelerated (GAcc) Encoders, as well as video quality measuring tool Video Quality Caliper (VQC). Previously HEVC Encoders and VQC tool were only available in the higher end Professional Edition.

The Essential Edition is same as the Community Edition in terms of technical features; the main difference is that the essentials edition also includes Priority Support that provides confidential access to Intel technical experts.

The Intel® Media Server Studio Professional Edition refers to an advanced bundle of features that primarily includes all the features of Essentials Edition as well as the Intel® VTune™ Amplifier, a premier profiler of performance for tuning of media applications.

#### Side-by-side Features Comparison of the two editions of Intel® Media Server Studio

<b>Components and Infrastructure</b>	<b>Intel® Media Server Studio Essentials/Community Edition</b>	<b>Intel® Media Server Professional Edition</b>
Intel® Media SDK with access to Intel® Quick Sync video that includes hardware accelerated codecs (MPEG-2, AVC, HEVC, VP8/9, and others) and video processing filters (denoising, deinterlacing, resizing, cropping, composition etc.)	√	√
Audio Decoders and Encoders	√	√
Splitter/Muxer support for MPEG-2 TS, and MP4	√	√
Graphics Drivers and runtimes	√	√
Code Samples for decode, encode, multi-transcode, and video processing	√	√
Flexible Encode Infrastructure (FEI) that allows developer to control encoding for best quality	√	√
Intel® SDK for OpenCL™ supports visualization and interactivity in	√	√

creating, building, debugging and analyzing applications undergoing optimization		
Metrics Monitor allows monitoring of GPU load, and utilization stats of hardware accelerators (VDBOX, VEBOX, and EU execution units)	✓	✓
HEVC Software Decoder & Software and GAcc Encoders	✓	✓
Video Quality Caliper Tool for measurement of video quality	✓	✓
Intel® VTune™ Amplifier profiles performance for tuning of media applications.		✓
License	Essential	Professional HEVC Encoder (up to 40 sockets)

### Intel® Media SDK stack, and HEVC Encoder Plugin Architecture

The Intel® Media Server Studio is built on Intel® Media SDK processing stack that uses plugin architecture for encoders and in Fig, 5B it shows hardware, software, and graphics accelerated HEVC encoders.

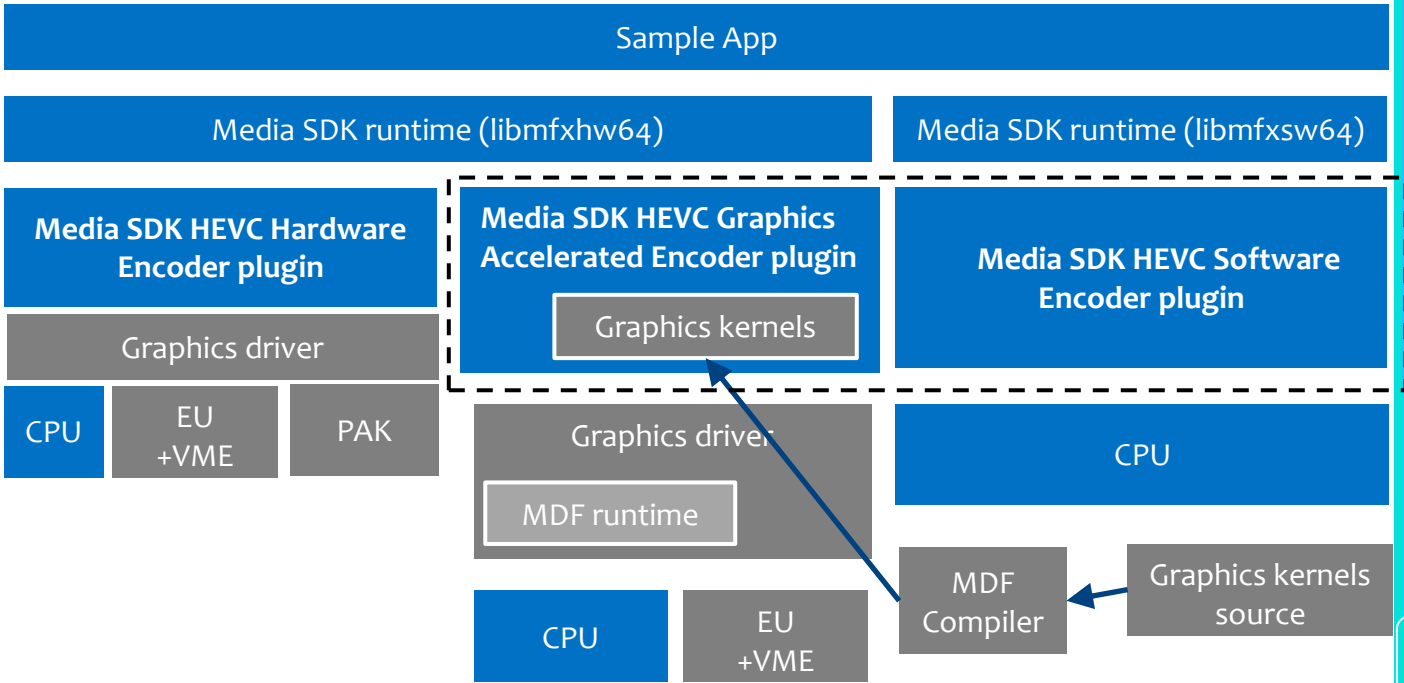

Figure 5B Intel® Media Server Studio SDK architecture stack

\*Other names and brands may be claimed as property of others.



The Media SDK HEVC Software, and GAcc Encoders share a common code base; both these Media SDK HEVC encoders are also used by Media Server Studio (MSS). The Media SDK for runtime for hardware (both HEVC Hardware Encoder and HEVC GAcc Encoder) is libfxhw64, while that for HEVC Software Encoder is libmfxsw64. Also, both HEVC Hardware Encoder and HEVC GAcc Encoder are accessed via the Graphics Driver. The hardware engine underlying HEVC Hardware encoder consists of VME+EUs, PAK, and to a small extent the CPU. The hardware engine employed by HEVC GAcc encoder consists of VME+EUs, and to some extent the CPU; it thus runs simultaneously on both the Graphics and the CPU. The HEVC GAcc Encoder uses Graphics Kernels that are generated by compiling Graphics Kernels source code by MDF compiler; an MDF runtime is thus needed to be included in the Graphics Driver. The HEVC Software Encoder runs purely on CPU and is designed to scale to available CPU resources.

## Recent additions to Intel® Media Server Studio/MSDK 2018 R1 HEVC Encoders

### What is new since the previous white paper (version 1.6 Aug. 2016)

- For HEVC Graphics Accelerated Encoder (GAcc), not only TU7-GAcc mode but also TU4-GAcc, TU5-GAcc, TU6-GAcc modes are now supported.
- Improvements in quantization for HEVC Encoding including use of lambda quantization as well as persistence based quantization
- Human region of Interest (HROI) is supported via detection of Face/Skin tone feature. By default this feature is off.
- Human Visual System (HVS) sensitive psycho-quantization has now been integrated.
- Reduced Live Encoding Latency and improved quality for Live encoding applications (the testing of this feature is however outside the scope of this white paper)
- Improved interlaced video coding quality (the testing of this feature is however outside the scope of this white paper)
- Improvement of subjective quality by content adaptive partitioning and mode decision.
- A number of bit-rate control modes are now supported such as CBR, VBR, and AVBR. Along with constant Qp (CQp), these BRC modes are evaluated in this white paper for their effectiveness.
- A streamlined methodology for quality testing is now employed in this white paper. For testing 4K 10-bit content, a new test set (based on AOM AV1 development) is defined and used.
- Quality analysis is now based on both PSNR, and MS-SSIM metrics that are used to calculate respective BD-rates.
- Updated the HM reference from HM14 to more recent HM16.18 for quality measurement tests.
- Performance measurement uses Intel® 6<sup>th</sup> gen core (SkyLake), and 8<sup>th</sup> gen core (CoffeeLake) based systems. HM performance measurement is also updated from previous white paper versions that used 4<sup>th</sup> gen core (Haswell) based system.

## *Part 1:*

# Coding Quality, and Performance in Encoding of High Definition (HD1080p) 8-bit content with Intel® Media Server Studio HEVC Software, and Graphics Accelerated (GAcc) Encoders

## Intel® Media Server Studio HEVC Software, and GAcc Encoders Quality Evaluation for HD1080p 8-bit video content

In this section, we first describe our general test methodology for evaluating quality of HEVC encoding and then report on comparison of results of detailed quality tests using the aforementioned methodology performed on Media Server Studio HEVC Software, and GAcc Encoders with respect to MPEG HEVC HM16.18 Encoder. As is well known, the HM Codec is an ideal quality reference codec however it is impractically slow.

### Quality Evaluation Test Methodology for HD1080p 8-bit

To measure quality of a coded/decoded image or video with respect to a high quality version of the same image or video used as reference, many objective quality metrics exist such as peak signal-to-noise ratio (PSNR), peak signal-to-noise ratio human visual system (PSNR-HVS), structural similarity index (SSIM), multi scale structural similarity index (MS-SSIM), newer combination metrics such as VMAF (Video Multi Method Assesment Fusion) and others. The goal of non-PSNR based objective metrics is of course to try to approximate as closely as possible how human visual system perceives image or video quality without the need of expensive, subjective quality tests.

In absence of significant consensus on the best objective metric that works well providing good approximation to visual quality as perceived by humans (while also being reasonable in computational costs), and based on our internal study of correlation of VQEG (Video Quality Expert Group's) test data to MOS (man opinion scores), MS-SSIM often offers a resonable approximation of to perceived visual quality. Thus, we use average value of MS-SSIM of a sequence in addition to PSNR of a sequence to fully classify coding quality of an coded sequence. Further, when the goal of the quality measurement is to classify the behaviour of a codec with respect to a reference codec over a range of bit-rates, we combine the above noted quality metrics with a statistically tractable technique curve fitting technique such as MPEG BD rate measure described next.

To compare video quality produced by a video codec being tested as compared to a reference codec, rate Distortion (RD) characteristics for both the codecs are computed using each codec's 4-point Quality Metric/Bitrate measurements followed MPEG's new BD rate ([5]) curve fitting procedure that generates a continuous RD curve that tightly fits to the measured points. A single measurement of 'goodness' of the codec being tested against the reference codec in the form of BD rate is then computed that reflects percentage difference between the codecs. The BD rate percentage difference if positive means that the codec being tested is worse in quality, that is it costs 'x' percentage more bits to generate the same PSNR quality as the reference. The BD rate difference measurement procedure thus allows a straightforward way of computing and independently verifying quality of codec with respect to a reference codec. In terms of specific quality metric for RD calculation, we use both the PSNR metric, as well as the MS-SSIM metric. Thus, we compute two values of BD rates, the first with respect to PSNR, and the second with respect to MS-SSIM; together the two BD rate values offer a fuller picture of quality of a codec as will be shown by our actual measurements.

## Quality Evaluation Test Set, Configurations and Parameters for HD1080p 8-bit

For the purpose of quality evaluation of HEVC Codecs, we define a test set of 6 publicly available challenging HD1080p 8 bit video test sequences at a variety of high frame rates. For the purpose of the tests, video content if not already in YUV 4:2:0 format, is converted to this format for input to MPEG HEVC HM, and MSS HEVC encoders.

The selected HD1080p test sequences are shown in Table 1A (and Table 1B). Out of these sequences, *Park\_Joy*, *Ducks\_take\_off*, *CrowdRun* and *TouchDownPass* of 1920x1080 resolution can be obtained from <http://media.xiph.org/video/derf/> while *BQTerrace* and *ParkScene* of 1920x1080 resolution are standard MPEG HEVC test sequences that can be obtained from MPEG distribution site such as <ftp://hvc:US88Hula@ftp.tnt.uni-hannover.de/testsequences>.

Table 1A **Quantizers** used for Qp based Codec RD characteristics measurement on **HD1080p 8 bit** Test Set

HD1080p 8 bit Test Set	Resolution	Bit depth	Frame rate	Num frms	Quantizers used for RD char.			
					Qp1	Qp2	Qp3	Qp4
1 <i>Park_joy</i>	1920x1080	8 bit	50	500	26	29	33	37
2 <i>Ducks_take_off</i>	1920x1080	8 bit	50	500	28	31	35	37
3 <i>CrowdRun</i>	1920x1080	8 bit	50	500	26	30	34	38
4 <i>TouchDownPass</i>	1920x1080	8 bit	30	570	23	26	30	34
5 <i>BQTerrace</i>	1920x1080	8 bit	60	600	25	27	31	34
6 <i>ParkScene</i>	1920x1080	8 bit	24	240	23	26	29	32

Further for each test sequence two types of tests are performed. The first type of tests are without bitrate control (no BRC) and require specifying quantizer (Qp) values, whereas the second type of tests are with bit rate control (BRC) and require specifying bitrate values.

Since we use MPEG's video quality measurement procedure, i.e., calculation of BD rate measure of an encoder with respect to HM encoder, to calculate the RD curve for the case of *no BRC* we need to specify four quantizer Qp values, while for the case of *BRC* we need to explicitly specify four bitrates per sequence; this is so as four points are needed per sequence to perform curve fitting. In a slight deviation to MPEG procedure, for the case of *no BRC*, instead of using four standard Qp values such as 22, 27, 32, 37 that assumes extreme ranges (of bitrates) of operation and thus larger errors in 4 point curve fitting, we provide, four Qp values per sequence (see Table 1A) that correspond to a moderate range of bitrates of useful applications and where curve fitting is more accurate. Further, to address the case of BRC tests, we provide for each sequence four bit-rate values specified in kbps as shown in Table 1B.

Now that we have introduced the test content, resolution/format, and coding bitrates we are ready to introduce coding configuration, and coding settings used for MPEG HEVC HM, and MSS HEVC Software, and MSS HEVC GAcc Encoders.

\*Other names and brands may be claimed as property of others.

Table 1B **Bitrates** used for BRC based Codec RD characteristics measurement on **HD1080p 8 bit** Test Set

HD1080p 8 bit Test Set	Resolution	Bit depth	Frame rate	Num frms	Bitrates (kbps) used for RD char.			
					BR1	BR2	BR3	BR4
1 Park_joy	1920x1080	8 bit	50	500	32000	16000	8000	4000
2 Ducks_take_off	1920x1080	8 bit	50	500	32000	16000	8000	4000
3 CrowdRun	1920x1080	8 bit	50	500	32000	16000	8000	4000
4 TouchDownPass	1920x1080	8 bit	30	570	6000	3000	1500	750
5 BQTerrace	1920x1080	8 bit	60	600	12000	6000	2000	1000
6 ParkScene	1920x1080	8 bit	24	240	5000	3000	2000	1000

HEVC HM encoding is employed in default high quality, high delay Random Access configuration but with only first frame Intra (other Intra's can still happen due to scene changes), pyramid configuration of 8 frames, and 4 Reference Pictures for prediction. For each of encoding tests, the reference quantizer is specified in Table 1A; this quantizer may be internally modulated into individual quantisers needed for I-, P- or B- pictures/slices, including that for reference and nonreference pictures/slices.

The Media Server Studio (MSS) HEVC software encoder is a pure software only encoder that supports a number of Target Usage (TU) settings that range from TU1 to TU7 such as TU1, TU2, TU3, TU4, TU5, TU6, and TU7 offering a gradual range of quality/speed tradeoffs with TU1 being the highest quality/slower speed to TU7 that is the lower quality/fastest speed. In fact, TU1 is referred to as the 'Quality' mode, TU4, as the 'Balanced' mode, and TU7 as the 'Speed' mode. For our quality evaluation tests, in terms of coding configuration and settings, we employ high delay B-pyramid encoding with pyramid length of 8 frames, and up to 4 reference pictures depending on the TU mode such as 4 reference pictures in case of TU1 mode, 3 reference pictures in case of TU4 mode, and 2 reference pictures for the case of TU7 mode. In our performance evaluation tests, we evaluate speed of TU1, TU4, TU5, TU6, and TU7 modes on a number of different PC configurations.

The Media Server Studio (MSS) HEVC GAcc encoder is a hybrid (software with Intel® Graphics accelerated) encoder that supports a number of Target Usage (TU) settings that range from TU4-GAcc to TU7-GAcc such as TU4-GAcc, TU5-GAcc, TU6-GAcc, and TU7-GAcc offering a range of quality/speed tradeoffs with TU4-GAcc being the good quality/moderate speed mode to TU7-GAcc that is the lower quality/fastest speed mode. Again, it would be appropriate to call TU4-GAcc, as the 'Balanced' mode, and TU7-GAcc as the 'Speed' mode. For our quality evaluation tests, in terms of configuration and settings, we employ high delay B-pyramid encoding with pyramid length set to 8, and either 3 or 2 reference pictures depending on the TU mode such as 3 reference pictures in case of TU4 mode, and 2 reference pictures for the case of TU7 mode. In our performance evaluation tests, we evaluate speed of TU4-GAcc, TU5-GAcc, TU6-GAcc, and TU7-GAcc modes. In terms of comparison of speed of MSS HEVC Software Encoder's TU4 mode vs MSS HEVC GAcc Encoder's TU4-GAcc mode, the TU4-GAcc mode is expected to be around 30% faster than the TU4 mode; this is also expected to be true for TU5 vs TU5-GAcc, TU6 vs TU6-GAcc, and TU7-TU7-GAcc modes.

As mentioned earlier, for evaluation of quality of MSS HEVC codecs with respect to HM16.18, we will be using the MPEG BD rate metric that performs curve fitting between four points for which measurements are made of a quality metric vs the bitrate. We will be employing two types of quality metrics, PSNR, and MS-SSIM, and thus we will calculate two types of BD-rate, the first wrt PSNR, and the second wrt MS-SSIM.

## Results of Quality Evaluation Tests for HD1080p 8-bit

Before discussing detailed BD rate differences of each MSS HEVC TU mode with respect to HM16.18, we first establish the quality/bitrate measurement of HM 16.18 that will be used as reference.

First, each video sequence of HD1080p is encoded using MPEG HEVC HM16.18 Reference Encoder with each of 4 quantizers as specified in Table 1A. As discussed earlier, coding configuration/settings include single intra (first) frame with exception for scene changes, pyramid frame configuration of size 8, and 4 references for prediction. The overall PSNR (averaged over all frames) for each test sequence for each Qp for each of luma (Y), and associated chroma components (U and V) is collected along with the generated coding bitrate. Further, the overall MS-SSIM (averaged over all frames) is also calculated for each test sequence for each Qp for luma (Y) component of frame only (while the chroma MS-SSIM can also be calculated in the same way, MS-SSIM was defined for luma only so it is customarily used in that manner).

For instance, Table 2 shows the results of HM16.18 encoding comprising of average luma PSNR (chroma PSNR is also collected but is not shown to keep tables manageable in size), average MS-SSIM, and total bitrate for each test sequence for each of 4 Qps.

Table 2 **HM16.18** Encoding results for each of 4 Qp's on **HD1080p 8 bit** Test set

HD1080p 8 bit Test Set	Qp1		Qp2		Qp3		Qp4	
	Y PSNR dB /MS-SSIM	Bitrate, kbps	Y PSNR dB /MS-SSIM	Bitrate, kbps	Y PSNR dB /MS-SSIM	Bitrate, kbps	Y PSNR dB /MS-SSIM	Bitrate, kbps
1 Park_joy	34.33 0.9880	35142.00	32.20 0.9810	21707.28	29.64 0.9651	10914.68	27.42 0.9380	5553.98
2 Ducks_take_off	32.23 0.9830	28304.32	30.69 0.9740	16347.92	28.81 0.9560	7993.00	27.93 0.9440	5589.49
3 CrowdRun	35.11 0.9871	25318.19	32.62 0.9780	13870.46	30.24 0.9600	7621.21	28.14 0.9330	4283.03
4 TouchDownPass	40.42 0.9870	5744.09	39.35 0.9831	2909.58	37.81 0.9740	1445.63	36.14 0.9590	791.66
5 BQTerrace	35.91 0.9860	12320.68	35.32 0.9840	6266.72	34.19 0.9790	2103.38	33.09 0.9740	1132.16
6 ParkScene	39.49 0.9910	5301.15	37.89 0.9870	3088.08	36.32 0.9810	1887.41	34.70 0.9720	1133.58

\*Other names and brands may be claimed as property of others.

For each sequence, for each of four Qps, the first line shows luma PSNR in dB of coded video, whereas the second line shows the corresponding MS-SSIM value (a floating point number in 0-1.0) range. These results are used in curve fitting to generate a continuous RD curve for HM16.18 encoding of that test sequence; the first corresponds to PSNR quality metric, and the second corresponds to MS-SSIM quality metric.

Next, MSS HEVC Software Encoder, and MSS HEVC GAcc Encoder undergo quality evaluation tests. For MSS HEVC Software Encoder, evaluation tests are conducted for five TU mode (TU1, TU4, TU5, TU6, TU7) each of which represents different quality/performance tradeoffs. Each test consists of performing encoding with MSS HEVC Encoder for a particular TU mode, each test sequence, for each of 4 quantizers, and from coded sequence calculating PSNRs of Y, U, and V, MS-SSIM of Y, and corresponding bitrates. This data is collected for all TU modes that need to be tested, and for each TU mode generating a continuous RD curve.

The RD curve for each sequence for each TU is then compared to HM16.18's RD curve and two BD rate percentages, one for each of two objective quality metrics (PSNR, and MS-SSIM) is computed that reflects the difference in quality between a test sequence's MSS TU mode and the HM16.18 reference. For instance a BD rate percentage of say 4% for MSS HEVC Software Encoder TU1 mode means that MSS HEVC Software Encoder TU1 mode in order to provide the same objective quality as HM16.18 would require 4% additional bits. For calculation of BD rate, the standard HEVC provided macro for BD rate is used.

Next, Table 3A shows for CQP based coding the measured BD rate based on PSNR as percentage (for luma, and chroma components), and BD rate based on MS-SSIM as percentage (for luma component) for each of for each test sequence of HD1080p test set shown in Table 1A for each of 5 TU modes (TU1, TU4, TU5, TU6, TU7) being evaluated.

Table 3A Quality comparison of **MSS HEVC Software Encoder** at various target usage (**TU**) settings with **MPEG HEVC HM 16.18 Encoder** on **HD1080p 8 bit** test set for constant Qp (**CQP**) based encoding. Two quality comparison metrics **BD rate** based on **PSNR** of luma and chroma, and **BD rate** based on **MS-SSIM** of luma are employed.

HD1080p 8 bit Test Set	TU1 CQP		TU4 CQP		TU5 CQP		TU6 CQP		TU7 CQP	
	% BD Rate based on PSNR/MS-SSIM		% BD Rate based on PSNR/MS-SSIM		% BD Rate based on PSNR/MS-SSIM		% BD Rate based on PSNR/MS-SSIM		% BD Rate based on PSNR/MS-SSIM	
	Y	U/V	Y	U/V	Y	U/V	Y	U/V	Y	U/V
1 Park_joy	1.29	3.11/-1.67	11.01	10.11/12.36	14.05	27.03/35.84	17.22	27.62/35.16	19.23	33.08/38.19
	2.17	-	14.17	-	18.63	-	21.71	-	23.95	-
2 Ducks_take_off	0.48	4.11/4.30	7.73	-1.11/7.80	10.67	4.30/21.44	11.66	4.75/22.11	14.50	11.20/25.36
	1.74	-	9.01	-	12.38	-	13.25	-	16.30	-
3 CrowdRun	0.92	1.41/1.09	13.63	21.58/22.77	18.40	35.52/37.30	25.40	39.24/40.85	27.17	43.04/45.05
	1.34	-	14.28	-	19.36	-	24.80	-	26.36	-
4 TouchDownPass	0.25	-6.34/-4.76	14.99	16.02/16.71	20.35	36.40/34.88	26.96	40.85/38.27	30.29	45.39/42.81
	-2.56	-	11.23	-	17.43	-	23.57	-	26.12	-
5 BQTerrace	3.66	-18.51/-24.43	23.14	-12.03/-5.07	32.13	7.57/20.10	40.01	7.49/20.11	41.35	9.90/20.42

	-0.79	-	15.52	-	25.83	-	32.69	-	34.10	-
6 ParkScene	2.58	-8.04/-9.99	17.61	7.40/3.02	21.14	20.54/14.56	29.23	24.87/17.44	31.31	28.34/20.35
	0.70	-	14.94	-	19.38	-	26.08	-	28.40	-
<b>Average</b>	<b>1.53</b>	<b>-4.05/-5.91</b>	<b>14.69</b>	<b>6.99/9.60</b>	<b>19.46</b>	<b>21.89/27.35</b>	<b>25.08</b>	<b>24.14/28.99</b>	<b>27.31</b>	<b>28.49/32.03</b>
	<b>0.43</b>	<b>-</b>	<b>13.19</b>	<b>-</b>	<b>18.83</b>	<b>-</b>	<b>23.68</b>	<b>-</b>	<b>25.87</b>	<b>-</b>

As can be observed for HD1080p 8 bit content in CQP based coding from Table 3A, average luma PSNR based BD rate percentage difference of MSS HEVC Software Encoder over HM16.18 (an ideal reference) is 1.5%, 14.7%, 19.5%, 25.1%, and 27.3% higher respectively for TU1, TU4, TU5, TU6, and TU7 modes. This means that for HD1080p test set, for MSS HEVC Software Encoder to achieve the same luma PSNR quality as HM16.18 requires in TU1 mode nearly the same bitrate as HM16.18, in TU4 mode 14.7% higher bitrate than HM16.18, in TU5 mode 19.5% higher bitrate than HM16.18, in TU6 mode 25.1% higher bitrate than HM16.18, and in TU7 mode 27.3% higher bitrate than HM16.18. Further for reference, MSS HEVC Software Encoder is 100 to 2000 times faster (depending on TU used, as shown in a later section) as compared to HEVC's HM16.18 Encoder implementation.

Since, MS-SSIM is expected to correlate closely to human visual perception of quality, we now perform a similar assessment of BD rate difference of MSS HEVC Software Encoder in various TU modes over HM16.18 Encoder, but with BD-rate based on MS-SSIM. Again, for HD1080p test set, Table 3A shows that the average luma MS-SSIM based BD rate percentage difference of MSS HEVC Software Encoder over HM16.18 (an ideal reference) is 0.4%, 13.2%, 18.8%, 23.7%, and 25.9% higher respectively in TU1, TU4, TU5, TU6, and TU7 modes.

This means that for HD1080p test set, the MSS HEVC Software Encoder to achieve the same luma MS-SSIM quality as HM16.18 requires in TU1 mode nearly the same bitrate as HM16.18, in TU4 mode 13.2% higher bitrate than HM16.18, in TU5 mode 18.8% higher bitrate than HM16.18, in TU6 mode 23.7% higher bitrate than HM16.18 in TU6, and in TU7 mode 25.9% higher bitrate than HM16.18. For HD1080p, in terms of comparing BD rate based on PSNR vs BD rate based on MS-SSIM, BD rate value based on MS-SSIM seems to be around 1.5% less for each TU's than the BD rate based on PSNR. This is so as for HD1080p 8 bit encoding, MSS HEVC Software Encoder includes specific algorithms to improve its results to correspond to subjective visual quality results; without these algorithms, BD rate based on MS-SSIM may be larger than BD rate based on PSNR.

Fig. 6A shows for HD1080p test set, luma PSNR based RD characteristics of the MSS HEVC Software Encoder TU1 mode with HM16.18 Encoder for the cases where their difference in quality is the highest (left-hand graph) and the lowest (right-hand graph). As can be seen, the difference between the two curves is very small not only for the lowest difference case, but also for the highest difference case. This along with BD rate data of Table 3A validates that based on PSNR, the quality of the MSS HEVC Software Encoder TU1 mode is practically identical to the HEVC HM reference encoder.

\*Other names and brands may be claimed as property of others.



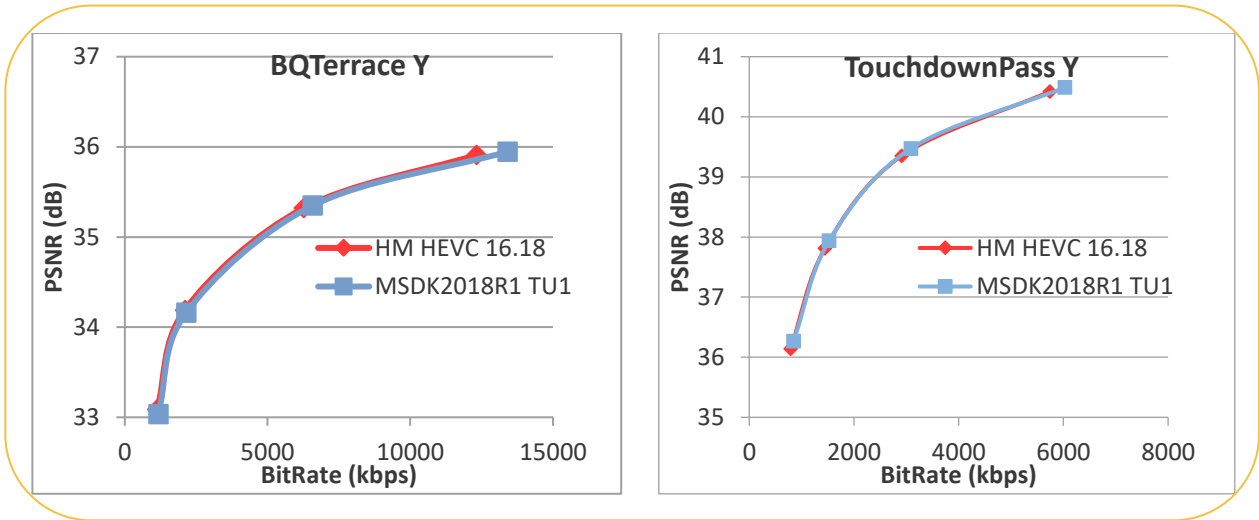

Figure 6A RD results of 1080p 8 bit sequences with the biggest and the smallest quality difference (based on BD rate based on PSNR) of MSS HEVC Software Encoder TU1 mode wrt HM16.18, both performing CQp based encoding.

Similarly, Fig. 6B shows for HD1080p test set, luma MS-SSIM based RD characteristics of the MSS HEVC Software Encoder TU1 mode with HM16.18 Encoder for the cases where their difference in quality is the highest (left-hand graph) and the lowest (right-hand graph). As can be seen, the difference between the two curves is very small not only for the lowest difference case, but also for the highest difference case. This along with BD rate data of Table 3A validates that also based on MS-SSIM, the quality of the MSS HEVC Software Encoder TU1 mode is practically identical to the HEVC HM reference encoder.

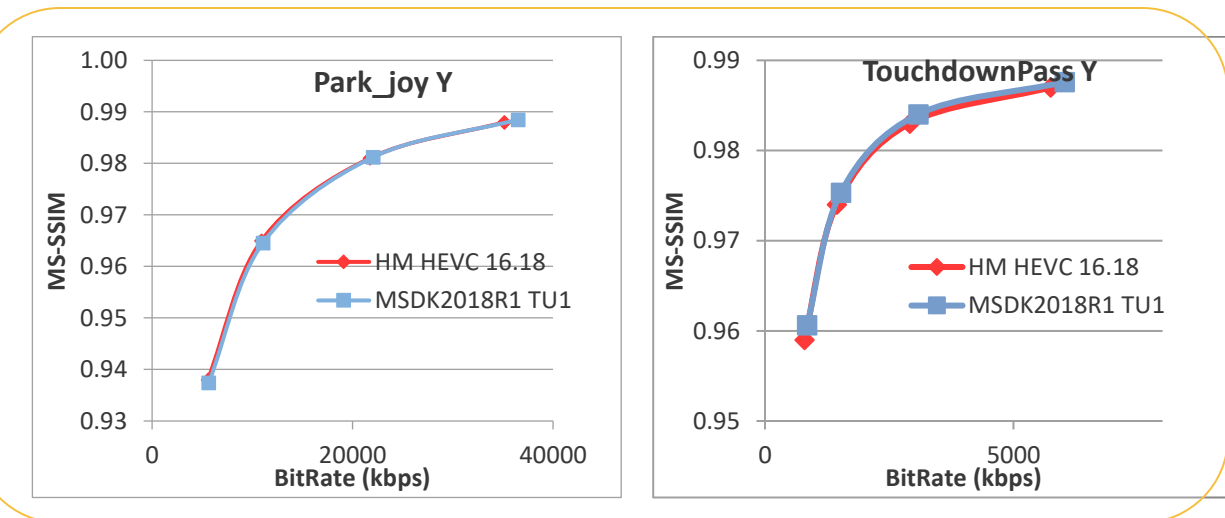

Figure 6B RD results of 1080p 8 bit sequences with the biggest and the smallest quality difference (based on BD rate based on MS-SSIM) of MSS HEVC Software Encoder TU1 mode wrt HM16.18, both performing CQp based encoding.

Next, for MSS HEVC GAcc Encoder, evaluation tests are conducted for four TU modes (TU4-GAcc, TU5-GAcc, TU6-GAcc, TU7-GAcc) each of which represents different quality/performance tradeoffs. Each test consists of performing encoding with MSS HEVC Encoder for a particular TU mode, each test sequence, for each of 4 quantizers, and from coded sequence calculating PSNRs of Y, U, and V, MS-SSIM of Y, and corresponding bitrates. This data is collected for all aforementioned TU modes, and for each TU mode a continuous RD curve is generated. The RD curve for each sequence for each TU-GAcc is then compared to HM16.18's RD curve and two BD rate percentages, one for each of two objective quality metrics (PSNR, and MS-SSIM) is computed that reflects the difference in quality between a MSS HEVC Encoder TU mode and the HM16.18 reference.

Table 3B shows for CQP based coding the measured BD rate based on PSNR as percentage (for luma, and chroma components), and BD rate based on MS-SSIM as percentage (for luma component) for each of for each test sequence of HD1080p test set shown in Table 1A for each of 4 TU modes (TU4-GAcc, TU5-GAcc, TU6-GAcc, TU7-GAcc) being evaluated.

Table 3B Quality comparison of **MSS HEVC GPU accelerated (GACC) Encoder** at various target usage (**TU**) settings with **MPEG HEVC HM 16.18 Encoder** on **HD1080p 8 bit** test set for constant Qp (**CQP**) based encoding. Two quality comparison metrics **BD rate** based on **PSNR** of luma and chroma, and **BD rate** based on **MS-SSIM** of luma are employed.

HD1080p 8 bit Test Set	TU4-GAcc CQP		TU5-GAcc CQP		TU6-GAcc CQP		TU7-GAcc CQP	
	% BD rate based on PSNR/MS-SSIM		% BD rate based on PSNR/MS-SSIM		% BD rate based on PSNR/MS-SSIM		% BD rate based on PSNR/MS-SSIM	
	Y	U/V	Y	U/V	Y	U/V	Y	U/V
1 Park_joy	10.76	8.88/11.07	13.57	25.95/34.29	16.75	30.71/38.13	18.92	37.01/41.82
	13.97	-	18.24	-	18.03	-	20.32	-
2 Ducks_take_off	7.68	-1.48/8.29	10.92	4.80/22.15	11.31	6.48/25.21	13.83	13.26/29.58
	8.97	-	12.74	-	11.39	-	14.17	-
3 CrowdRun	14.79	21.74/22.78	19.05	36.23/37.92	23.20	43.24/45.57	25.09	48.19/50.87
	15.46	-	20.29	-	21.83	-	23.46	-
4 TouchDownPass	14.12	12.82/13.93	19.05	35.12/34.38	25.98	44.0/43.62	28.26	48.27/48.38
	10.75	-	16.87	-	22.04	-	24.22	-
5 BQTerrace	24.88	-15.65/-8.57	33.95	4.04/18.36	39.74	5.79/23.78	40.87	8.26/23.47
	16.29	-	27.30	-	31.05	-	32.38	-
6 ParkScene	18.52	7.05/2.49	21.85	20.93/14.80	29.24	28.32/21.4	31.21	32.44/24.57
	15.79	-	20.08	-	24.95	-	27.03	-
Average	15.13	5.56/8.33	19.73	21.18/26.98	24.37	26.42/32.96	26.36	31.24/36.45
	13.54	-	19.25	-	21.55	-	23.59	-

\*Other names and brands may be claimed as property of others.

As can be observed for HD1080p 8 bit content for CQp based coding from Table 3B, average luma PSNR based BD rate percentage difference of MSS HEVC GAcc Encoder over HM16.18 (an ideal reference) is 15.1%, 19.7%, 24.4%, and 26.4% higher respectively for TU4-GAcc, TU5-GAcc, TU6-GAcc, and TU7-GAcc modes. This means that for HD1080p test set, for MSS HEVC GAcc Encoder to achieve the same luma PSNR quality as HM16.18 requires in TU4-GAcc mode 15.1% higher bitrate than HM16.18, in TU5-GAcc mode 19.7% higher bitrate than HM16.18, in TU6-GAcc mode 24.4% higher bitrate than HM16.18, and in TU7-GAcc mode 26.4% higher bitrate than HM16.18. These quality numbers for MSS HEVC GAcc Encoder compare favorably (within 1-2%) of the numbers of MSS HEVC Software Encoder. Further for reference, MSS HEVC GAcc Encoder is 900 to 2700 times faster (depending on TU used, as shown in a later section) as compared to HEVC's HM16.18 Encoder implementation.

Since, MS-SSIM is expected to correlate closely to human visual perception of quality, we now perform a similar assessment of BD rate difference of MSS HEVC GAcc Encoder in various TU modes over HM16.18, but with BD-rate based on MS-SSIM. Again, for HD1080p test set undergoing CQp coding, Table 3B shows that the average luma MS-SSIM based BD rate percentage difference of MSS HEVC Software Encoder over HM16.18 is 13.5%, 19.3%, 21.6%, and 23.6% higher respectively in TU4-GAcc, TU5-GAcc, TU6-GAcc, and TU7-GAcc modes. This means that for HD1080p test set, the MSS HEVC Software Encoder to achieve the same luma MS-SSIM quality as HM16.18 requires in TU4-GAcc mode 13.5% higher bitrate than HM16.18, in TU5-GAcc mode 19.3% higher bitrate than HM16.18, in TU6-GAcc mode 21.6% higher bitrate than HM16.18, and in TU7-GAcc mode 23.6% higher bitrate than HM16.18. For HD1080p, in terms of comparing BD rate based on PSNR vs BD rate based on MS-SSIM, BD rate value based on MS-SSIM seems to be around 1-3% less for each TU's than the BD rate based on PSNR. This is due to specific algorithms to improve results of MSS HEVC GAcc with respect to subjective visual quality.

Fig. 6C1 and Fig. 6C2 show for TU4 mode, measured PSNR based RD characteristics of MSS HEVC Software Encoder, and measured PSNR based RD characteristics of MSS HEVC GAcc Encoder with respect to HM 16.18 Encoder respectively.

In Fig. 6C1, the left-hand graph shows PSNR based RD curves of MSS HEVC Software Encoder TU4 mode, and that of the HM 16.18 Encoder for the case when the quality difference between the two is the largest from among the sequences in the test set, and the right-hand graph shows the PSNR based RD curves of MSS HEVC Software Encoder TU4 mode, and that of the HM 16.18 Encoder for the case when the quality difference between the two is the smallest from among the sequences in the test set.

As can be seen from Table 3A, for MSS HEVC Software Encoder TU4 mode or the BD rate (based on PSNR) between the two curves is 23.1% for the case of largest difference and only 7.7% for the case of smallest difference. This along with visuals of Fig. 6C1 confirms that based on PSNR, the quality of the MSS HEVC Software Encoder TU4 mode is between very good to good as compared to the HEVC HM encoder.

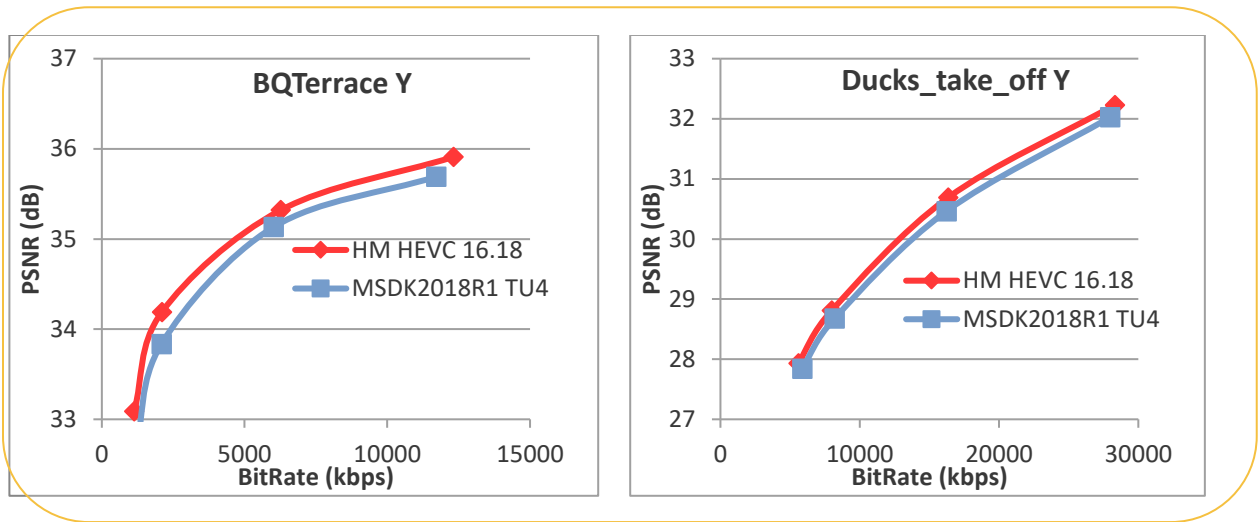
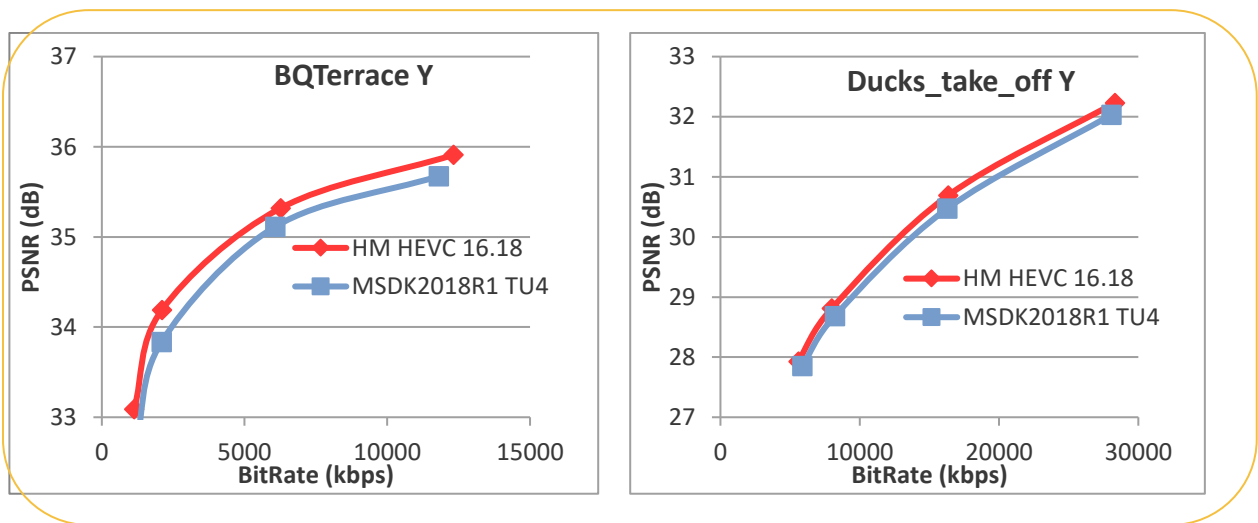

Figure 6C1 RD results of 1080p 8 bit sequences with the biggest and the smallest quality difference (based on BD rate based on PSNR) of MSS HEVC Software Encoder TU4 mode wrt HM16.18, both performing CQp based encoding.

Similarly in Fig. 6C2 the left-hand graph shows PSNR based RD curves of MSS HEVC GAcc Encoder TU4 mode, and that of the HM 16.18 Encoder for the case when the quality difference between the two is the largest from among the sequences in the test set, and the right-hand graph shows the PSNR based RD curves of MSS HEVC GAcc Encoder TU4 mode, and that of the HM 16.18 Encoder for the case when the quality difference between the two is the smallest from among the sequences in the test set.

As can be seen from Table 3B, for MSS HEVC GAcc Encoder TU4 mode the BD rate (based on PSNR) between the two curves is 24.9% for the case of largest difference and only 7.7% for the case of smallest difference. This along with visuals of Fig. 6C2 confirms that based on PSNR, the quality of the MSS HEVC Software Encoder TU4 mode is between very good to good as compared to the HEVC HM encoder.



\*Other names and brands may be claimed as property of others.

Figure 6C2 RD results of 1080p 8 bit sequences with the biggest and the smallest quality difference (based on BD rate based on PSNR) of MSS HEVC GAcc Encoder TU4 mode wrt HM16.18, both performing CQp based encoding.

Next, Fig. 6D1 and Fig. 6D2 show for TU4 mode, measured MS-SSIM based RD characteristics of MSS HEVC Software Encoder, and measured MS-SSIM based RD characteristics of MSS HEVC GAcc Encoder with respect to HM 16.18 Encoder respectively.

In Fig. 6D1 the left-hand graph shows MS-SSIM based RD curves of MSS HEVC Software Encoder TU4 mode, and that of the HM 16.18 Encoder for the case when the quality difference between the two is the largest from among the sequences in the test set, and the right-hand graph shows the MS-SSIM based RD curves of MSS HEVC Software Encoder TU4 mode, and that of the HM 16.18 Encoder for the case when the quality difference between the two is the smallest from among the sequences in the test set.

As can be seen from Table 3A, for MSS HEVC Software Encoder TU4 mode or the BD rate (based on MS-SSIM) between the two curves is 15.5% for the case of largest difference and only 9% for the case of smallest difference. This along with visuals of Fig. 6D1 confirms that based on MS-SSIM, the quality of the MSS HEVC Software Encoder TU4 mode is between very good to good as compared to the HEVC HM encoder.

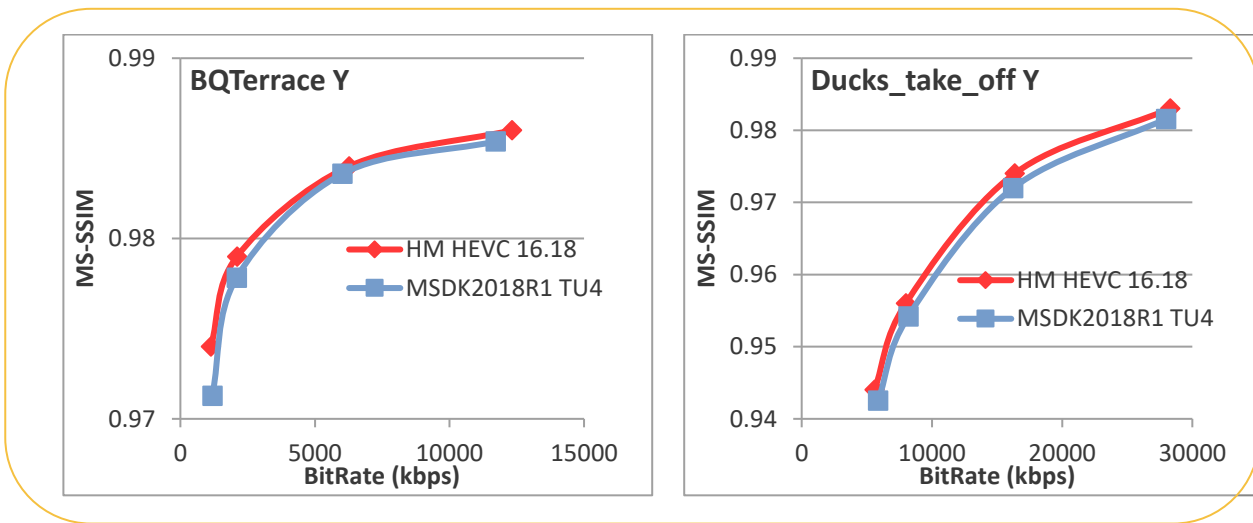

Figure 6D1 RD results of 1080p 8 bit sequences with the biggest and the smallest quality difference (based on BD rate based on MS-SSIM) of MSS HEVC Software Encoder TU4 mode wrt HM16.18, both performing CQp based encoding.

In Fig. 6D2 the left-hand graph shows MS-SSIM based RD curves of MSS HEVC GAcc Encoder TU4 mode, and that of the HM 16.18 Encoder for the case when the quality difference between the two is the largest from among the sequences in the test set, and the right-hand graph shows the MS-SSIM based RD curves of MSS HEVC Software Encoder TU4 mode, and that of the HM 16.18 Encoder for the case when the quality difference between the two is the smallest from among the sequences in the test set.

As can be seen from Table 3B, for MSS HEVC GAcc Encoder TU4 mode or the BD rate (based on MS-SSIM) between the two curves is 16.3% for the case of largest difference and only 8.9% for the case of smallest difference. This along with visuals of Fig. 6D2 confirms that based on MS-SSIM, the quality of the MSS HEVC GAcc Encoder TU4 mode is between very good to good as compared to the HEVC HM encoder.

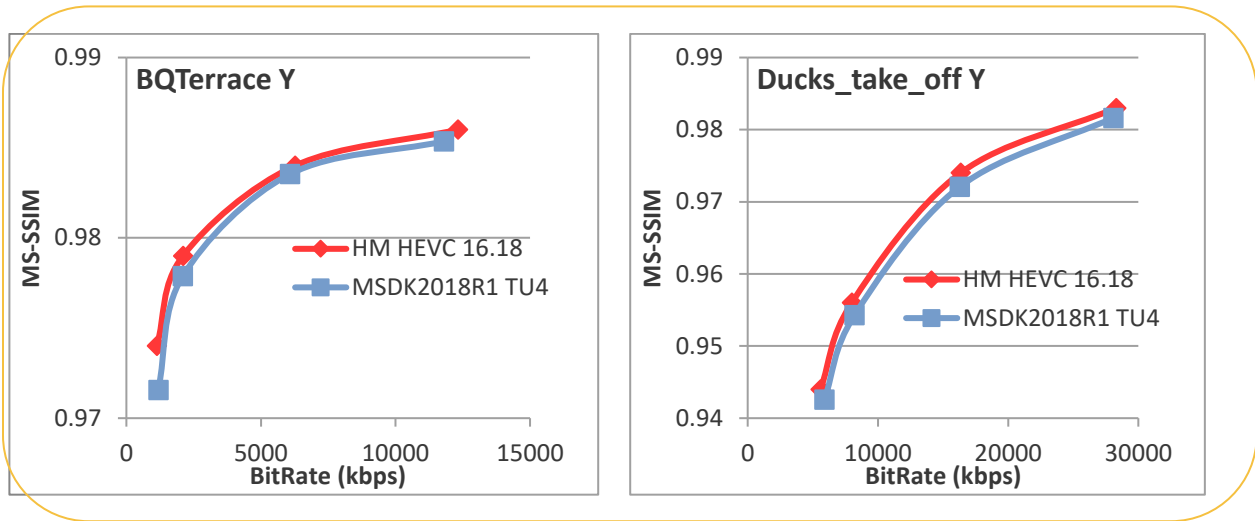

Figure 6D2 RD results of 1080p 8 bit sequences with the biggest and the smallest quality difference (based on BD rate based on MS-SSIM) of MSS HEVC GAcc Encoder TU4 mode wrt HM16.18, both performing CQp based encoding.

Next, Fig. 6E1 and Fig. 6E2 show for TU7 mode, measured PSNR based RD characteristics of MSS HEVC Software Encoder, and measured PSNR based RD characteristics of MSS HEVC GAcc Encoder with respect to HM 16.18 Encoder respectively.

In Fig. 6E1, the left-hand graph shows PSNR based RD curves of MSS HEVC Software Encoder TU7 mode, and that of the HM 16.18 Encoder for the case when the quality difference between the two is the largest from among the sequences in the test set, and the right-hand graph shows the PSNR based RD curves of MSS HEVC Software Encoder TU7 mode, and that of the HM 16.18 Encoder for the case when the quality difference between the two is the smallest from among the sequences in the test set.

As can be seen from Table 3A, for MSS HEVC Software Encoder TU7 mode or the BD rate (based on PSNR) between the two curves is 41.4% for the case of largest difference and only 14.5% for the case of smallest difference. This along with visuals of Fig. 6E1 confirms that based on PSNR, the quality of the MSS HEVC Software Encoder TU7 mode is between good to fair as compared to the HEVC HM encoder.

\*Other names and brands may be claimed as property of others.

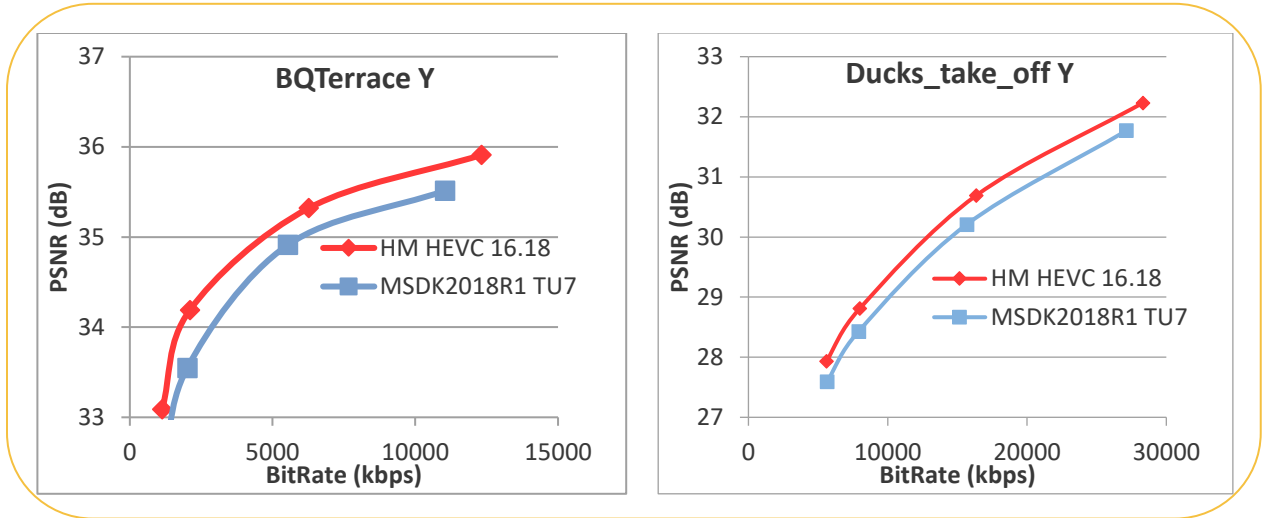

Figure 6E1 RD results of 1080p 8 bit sequences with the biggest and the smallest quality difference (based on BD rate based on PSNR) of MSS HEVC Software Encoder TU7 mode wrt HM16.18, both performing CQp based encoding.

In Fig. 6E2, the left-hand graph shows PSNR based RD curves of MSS HEVC GAcc Encoder TU7 mode, and that of the HM 16.18 Encoder for the case when the quality difference between the two is the largest from among the sequences in the test set, and the right-hand graph shows the PSNR based RD curves of MSS HEVC GAcc Encoder TU7 mode, and that of the HM 16.18 Encoder for the case when the quality difference between the two is the smallest from among the sequences in the test set.

As can be seen from Table 3B, for MSS HEVC GAcc TU7 mode or the BD rate (based on PSNR) between the two curves is 40.9% for the case of largest difference and only 13.8% for the case of smallest difference. This along with visuals of Fig. 6E2 confirms that based on PSNR, the quality of the MSS HEVC GAcc Encoder TU7 mode is between good to fair as compared to the HEVC HM encoder.

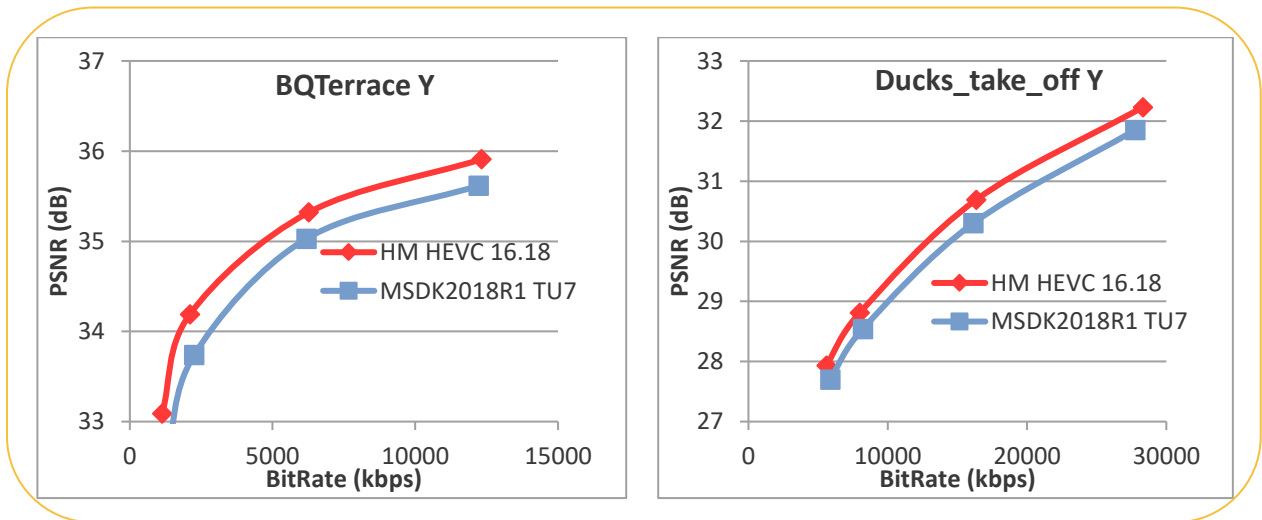

Figure 6E2 RD results of 1080p 8 bit sequences with the biggest and the smallest quality difference (based on BD rate based on PSNR) of MSS HEVC GAcc Encoder TU7 mode wrt HM16.18, both performing CQP based encoding.

Next, Fig. 6F1 and Fig. 6F2 show for TU7 mode, measured SSIM based RD characteristics of MSS HEVC Software Encoder, and measured MS-SSIM based RD characteristics of MSS HEVC GAcc Encoder with respect to HM 16.18 Encoder respectively.

In Fig. 6F1, the left-hand graph shows MS-SSIM based RD curves of MSS HEVC Software Encoder TU7 mode, and that of the HM 16.18 Encoder for the case when the quality difference between the two is the largest from among the sequences in the test set, and the right-hand graph shows the MS-SSIM based RD curves of MSS HEVC Software Encoder TU7 mode, and that of the HM 16.18 Encoder for the case when the quality difference between the two is the smallest from among the sequences in the test set.

As can be seen from Table 3A, for MSS HEVC Software Encoder TU7 mode or the BD rate (based on MS-SSIM) between the two curves is 34.1% for the case of largest difference and only 16.3% for the case of smallest difference. This along with visuals of Fig. 6F1 confirms that based on MS-SSIM, the quality of the MSS HEVC Software Encoder TU7 mode is between good to fair as compared to the HEVC HM encoder.

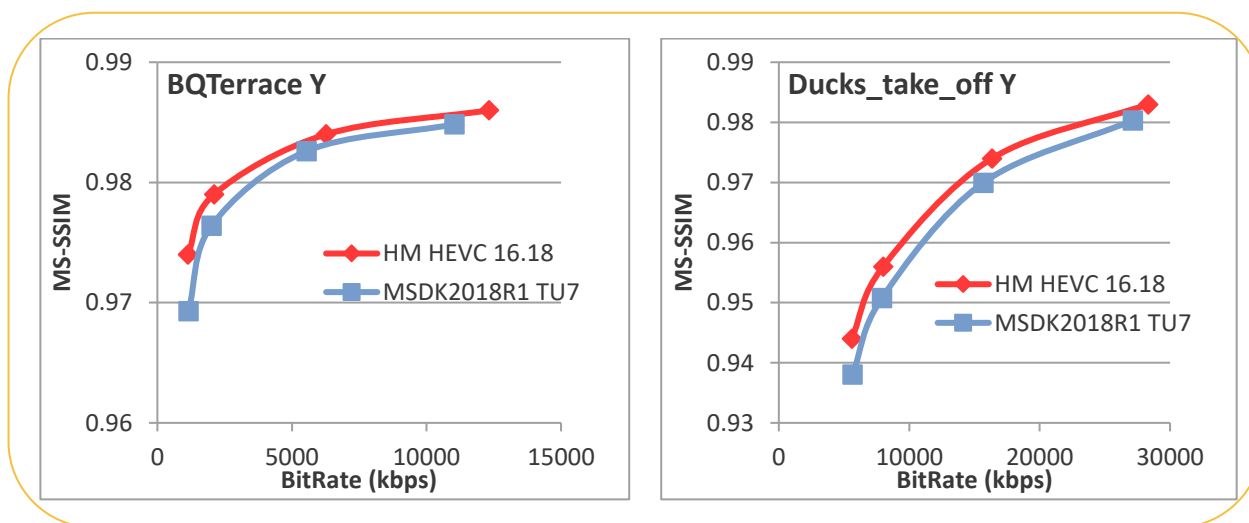

Figure 6F1 RD results of 1080p 8 bit sequences with the biggest and the smallest quality difference (based on BD rate based on MS-SSIM) of MSS HEVC Software Encoder TU7 mode wrt HM16.18, both performing CQP based encoding.

In Fig. 6F2, the left-hand graph shows MS-SSIM based RD curves of MSS HEVC GAcc Encoder TU7 mode, and that of the HM 16.18 Encoder for the case when the quality difference between the two is the largest from among the sequences in the test set, and the right-hand graph shows the MS-SSIM based RD curves of MSS HEVC GAcc Encoder TU7 mode, and that of the HM 16.18 Encoder for the case when the quality difference between the two is the smallest from among the sequences in the test set.

\*Other names and brands may be claimed as property of others.



As can be seen from Table 3B, for MSS HEVC GAcc Encoder TU7 mode or the BD rate (based on MS-SSIM) between the two curves is 32.4% for the case of largest difference and only 14.2% for the case of smallest difference. This along with visuals of Fig. 6F2 confirms that based on MS-SSIM, the quality of the MSS HEVC GAcc Encoder TU7 mode is between good to fair as compared to the HEVC HM encoder.

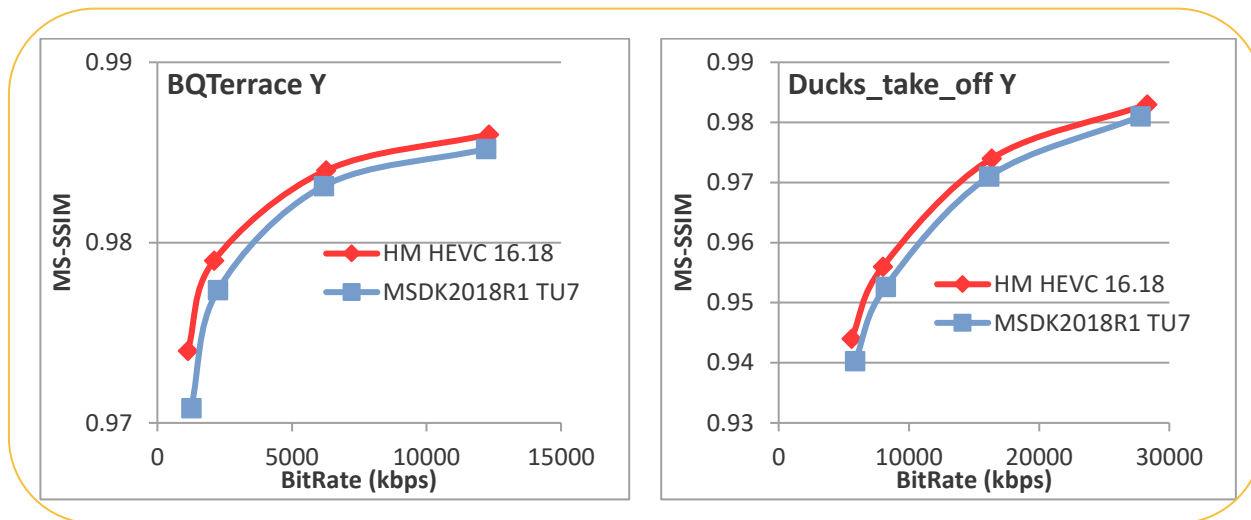

Figure 6F2 RD results of 1080p 8 bit sequences with the biggest and the smallest quality difference (based on BD rate based on MS-SSIM) of MSS HEVC GAcc Encoder TU7 mode wrt HM16.18, both performing CQP based encoding.

To summarize, for the case of constant Qp (CQp), luma BD rate percentage bitrate difference (based on PSNR or MS-SSIM) of MSS HEVC in various modes with respect to HM16.18 reference encoder is as follows.

- TU1 mode on average is nearly the same in quality (while on average over 90 times faster, as shown later) as compared to HM16.18, an ideal reference. This is highest quality mode for HD1080p 8 bit encoding in MSS HEVC Software Encoder.
- TU4 mode based on PSNR on average is only 14.7% lower in quality (while on average over 600 times faster) as compared to HM16.18. This mode represents excellent tradeoff of quality vs speed.
- TU4-GAcc mode based on PSNR on average has the same quality as TU4 mode quality (while on average around 1.6x faster than TU4 at 970 times faster) as compared to HM16.18.
- TU7 mode based on PSNR on average is 27.3% lower in quality (while on average around 2000 times faster) as compared to HM16.18. This is the fastest software only mode for HD1080p 8-bit encoding in MSS HEVC Software Encoder.
- TU7-GAcc mode on average has the same quality as TU7 mode (while on average around 1.4x faster times than TU7 at 2750 times faster) as compared to HM16.18. This is the fastest mode for HD1080p 8-bit encoding in MSS HEVC Software or GAcc Encoders.

Up to now we have discussed constant Qp based encoding where using four quantizer values per sequence we were able to generate RD characteristics curve for MSS HEVC Software and MSS HEVC GAcc Encoders. Further we also calculated similar RD curve for HM 16.18 Encoder, and compared BD rate (based on PSNR, and based on MS-SSIM) between corresponding RD curves per sequence of MSS HEVC Software and MSS HEVC GAcc Encoders with respect to HM 16.18 Encoder.

Now we present results of BRC tests consisting of CBR mode test results, VBR mode test results, and AVBR mode test results.

Table 4A shows for CBR based coding the measured BD rate based on PSNR as percentage (for luma, and chroma components), and BD rate based on MS-SSIM as percentage (for luma component) for each of for each test sequence of HD1080p test set shown in Table 1A for each of 5 TU modes (TU1, TU4, TU5, TU6, TU7) being evaluated.

Table 4A Quality comparison of **MSS HEVC Software Encoder** at various target usage (TU) settings with **MPEG HEVC HM 16.18 Encoder** on **HD1080p 8 bit** test set for constant bitrate (CBR) based encoding. Two quality comparison metrics **BD rate** based on **PSNR** of luma and chroma, and **BD rate** based on **MS-SSIM** of luma are employed.

HD1080p 8 bit Test Set	TU1 CBR		TU4 CBR		TU5 CBR		TU6 CBR		TU7 CBR	
	% BD Rate based on PSNR/MS-SSIM		% BD Rate based on PSNR/MS-SSIM		% BD Rate based on PSNR/MS-SSIM		% BD Rate based on PSNR/MS-SSIM		% BD Rate based on PSNR/MS-SSIM	
	Y	U/V	Y	U/V	Y	U/V	Y	U/V	Y	U/V
1 Park_joy	0.53	-2.76/-11.45	9.74	3.59/1.52	12.75	14.69/15.46	15.78	16.46/16.39	17.93	20.88/18.23
	-2.61	-	8.33	-	12.03	-	15.40	-	17.55	-
2 Ducks_take_off	2.52	-70/-5.38	9.12	-5.70/.64	11.35	1.33/13.95	12.11	2.09/14.73	14.97	8.23/18.06
	7.45	-	14.02	-	16.06	-	16.67	-	19.90	-
3 CrowdRun	2.71	-2.67/-2.31	15.75	12.87/14.62	19.47	30.74/32.71	26.54	34.19/36.23	28.45	38.28/40.60
	-2.83	-	10.35	-	14.17	-	20.08	-	21.99	-
4 TouchDownPass	3.97	-9.36/-3.93	18.72	11.07/16.08	23.54	31.93/37.95	30.05	34.83/40.97	33.52	39.80/46.34
	8.63	-	22.80	-	28.99	-	35.41	-	38.68	-
5 BQTerrace	17.89	-10.44/-14.00	37.63	-1.19/10.09	47.32	13.91/33.07	55.19	13.32/30.99	57.22	15.52/32.56
	7.09	-	21.89	-	30.83	-	37.13	-	39.30	-
6 ParkScene	4.64	-7.01/-10.78	18.57	5.67/-22	21.56	17.71/10.65	29.58	20.77/12.56	31.57	24.44/15.36
	2.73	-	16.08	-	19.73	-	26.18	-	28.45	-
Average	5.38	-5.49/-7.97	18.25	4.38/7.12	22.67	18.39/23.97	28.21	20.28/25.31	30.61	24.53/28.53
	3.41	-	15.58	-	20.30	-	25.14	-	27.64	-

As can be observed for HD1080p 8 bit content in CBR based coding from Table 4A, average luma PSNR based BD rate percentage difference of MSS HEVC Software Encoder over HM16.18 is 5.4%, 18.3%, 22.7%,

\*Other names and brands may be claimed as property of others.

28.2%, and 30.6% higher respectively for TU1, TU4, TU5, TU6, and TU7 modes. This means that for HD1080p test set, for MSS HEVC Software Encoder in CBR based coding to achieve the same luma PSNR quality as HM16.18 requires in TU1 mode 5.4% more bitrate as HM16.18, in TU4 mode 18.3% higher bitrate than HM16.18, in TU5 mode 22.7% higher bitrate than HM16.18, in TU6 mode 28.2% higher bitrate than HM16.18, and in TU7 mode 30.6% higher bitrate than HM16.18.

Further for HD1080p test set in CBR based coding from Table 4A also shows that the average luma MS-SSIM based BD rate percentage difference of MSS HEVC Software Encoder over HM16.18 is 3.4%, 15.6%, 20.3%, 25.1%, and 27.6% higher respectively in TU1, TU4, TU5, TU6, and TU7 modes. This means that for HD1080p test set, the MSS HEVC Software Encoder to achieve the same luma PSNR quality as HM16.18 requires in TU1 mode nearly 3% more bitrate than HM16.18, in TU4 mode 15.6% higher bitrate than HM16.18, in TU5 mode 20.3% higher bitrate than HM16.18, in TU6 mode 25.1% higher bitrate than HM16.18 in TU6, and in TU7 mode 27.6% higher bitrate than HM16.18. For HD1080p, in terms of comparing BD rate based on PSNR vs BD rate based on MS-SSIM, BD rate value based on MS-SSIM seems to be around 3% less for each TU's than the BD rate based on PSNR.

Table 4B shows for CBR based coding the measured BD rate based on PSNR as percentage (for luma, and chroma components), and BD rate based on MS-SSIM as percentage (for luma component) for each of for each test sequence of HD1080p test set shown in Table 1A for each of 4 TU modes (TU4-GAcc, TU5-GAcc, TU6-GAcc, TU7-GAcc) being evaluated.

Table 4B Quality comparison of **MSS HEVC GPU accelerated (GACC) Encoder** at various target usage (**TU**) settings with **MPEG HEVC HM 16.18 Encoder** on **HD1080p 8 bit** test set for constant bitrate (**CBR**) based encoding. Two quality comparison metrics **BD rate** based on **PSNR** of luma and chroma, and **BD rate** based on **MS-SSIM** of luma are employed.

HD1080p 8bit Test Set	TU4-GAcc CBR		TU5-GAcc CBR		TU6-GAcc CBR		TU7-GAcc CBR	
	% BD rate based on PSNR/MS-SSIM		% BD rate based on PSNR/MS-SSIM		% BD rate based on PSNR/MS-SSIM		% BD rate based on PSNR/MS-SSIM	
	Y	U/V	Y	U/V	Y	U/V	Y	U/V
1 Park_joy	9.73	4.00/1.26	12.38	16.45/16.30	15.80	20.77/19.81	17.89	26.49/23.09
	2.78	-	5.99	-	7.42	-	9.84	-
2 Ducks_take_off	10.07	-6.76/1.12	12.68	1.36/12.91	13.35	3.49/16.49	16.09	9.82/20.47
	9.61	-	12.13	-	10.97	-	13.98	-
3 CrowdRun	16.65	13.82/15.46	19.94	32.21/34.44	24.09	38.84/41.95	26.18	44.58/48.03
	7.73	-	11.33	-	13.57	-	15.27	-
4 TouchDownPass	17.83	9.24/15.79	22.47	33.18/41.16	29.25	40.49/50.72	31.26	45.36/55.17
	18.37	-	25.05	-	30.64	-	32.29	-
5 BQTerrace	41.91	-3.26/8.07	52.21	14.06/36.64	56.41	14.60/36.96	58.06	17.71/38.90
	19.89	-	30.19	-	32.57	-	33.97	-
6 ParkScene	20.50	7.56/1.09	23.73	19.75/12.27	30.50	27.68/18.77	32.35	31.26/21.79

	15.31	-	19.43	-	23.81	-	25.78	-
<b>Average</b>	<b>19.45</b>	<b>4.10/6.96</b>	<b>23.90</b>	<b>19.50/25.62</b>	<b>28.23</b>	<b>24.31/30.78</b>	<b>30.30</b>	<b>29.20/34.58</b>
	12.28	-	17.35	-	19.83	-	21.86	-

As can be observed for HD1080p 8 bit content for CBR based coding from Table 4B, average luma PSNR based BD rate percentage difference of MSS HEVC GAcc Encoder over HM16.18 is 19.5%, 23.9%, 28.2%, and 30.3% higher respectively for TU4-GAcc, TU5-GAcc, TU6-GAcc, and TU7-GAcc modes. This means that for HD1080p test set, for MSS HEVC GAcc Encoder in CBR based coding to achieve the same luma PSNR quality as HM16.18 requires in TU4-GAcc mode 19.5% higher bitrate than HM16.18, in TU5-GAcc mode 23.9% higher bitrate than HM16.18, in TU6-GAcc mode 28.2% higher bitrate than HM16.18, and in TU7-GAcc mode 30.3% higher bitrate than HM16.18. These PSNR based quality numbers for MSS HEVC GAcc Encoder are almost the same as the numbers of MSS HEVC Software Encoder.

Again, for HD1080p test set undergoing CBR coding, Table 4B also shows that the average luma MS-SSIM based BD rate percentage difference of MSS HEVC Software Encoder over HM16.18 is 12.3%, 17.4%, 19.8%, and 21.9% higher respectively in TU4-GAcc, TU5-GAcc, TU6-GAcc, and TU7-GAcc modes. This means that for HD1080p test set, the MSS HEVC Software Encoder to achieve the same luma MS-SSIM quality as HM16.18 requires in TU4-GAcc mode 12.3% higher bitrate than HM16.18, in TU5-GAcc mode 17.4% higher bitrate than HM16.18, in TU6-GAcc mode 19.8% higher bitrate than HM16.18, and in TU7-GAcc mode 21.9% higher bitrate than HM16.18. For HD1080p, in terms of comparing BD rate based on PSNR vs BD rate based on MS-SSIM, BD rate value based on MS-SSIM seems to be around 7-9% less for each TU's than the BD rate based on PSNR.

Table 5A shows for VBR based coding the measured BD rate based on PSNR as percentage (for luma, and chroma components), and BD rate based on MS-SSIM as percentage (for luma component) for each of for each test sequence of HD1080p test set shown in Table 1A for each of 5 TU modes (TU1, TU4, TU5, TU6, TU7) being evaluated.

Table 5A Quality comparison of **MSS HEVC Software Encoder** at various target usage (TU) settings with **MPEG HEVC HM 16.18 Encoder** on **HD1080p 8 bit** test set for variable bitrate (VBR) based encoding. Two quality comparison metrics **BD rate** based on **PSNR** of luma and chroma, and **BD rate** based on **MS-SSIM** of luma are employed.

HD1080p 8 bit Test Set	TU1 VBR		TU4 VBR		TU5 VBR		TU6 VBR		TU7 VBR	
	% BD Rate based on PSNR/MS-SSIM		% BD Rate based on PSNR/MS-SSIM		% BD Rate based on PSNR/MS-SSIM		% BD Rate based on PSNR/MS-SSIM		% BD Rate based on PSNR/MS-SSIM	
	Y	U/V	Y	U/V	Y	U/V	Y	U/V	Y	U/V
1 Park_joy	0.53	-2.76/-11.45	9.74	3.59/1.52	12.75	14.69/15.46	15.78	16.46/16.3	17.93	20.88/18.23
	-2.61	-	8.33	-	12.03	-	15.40	-	17.55	-
2 Ducks_take_off	2.52	-70/-5.38	9.12	-5.70/.64	11.35	1.33/13.95	12.11	2.09/14.73	14.97	8.23/18.06
	7.45	-	14.02	-	16.06	-	16.67	-	19.90	-

\*Other names and brands may be claimed as property of others.

3	CrowdRun	2.71 -2.83	-2.67/-2.31 -	15.75 10.35	12.87/14.62 -	19.47 14.17	30.74/32.71 -	26.54 20.08	34.19/36.23 -	28.45 21.99	38.28/40.60 -
4	TouchDownPass	1.55 7.74	-9.21/-4.61 -	16.03 21.47	10.89/15.3 -	21.52 29.27	33.58/38.86 -	27.68 35.17	37.12/42.61 -	31.25 38.03	40.96/46.48 -
5	BQTerrace	18.11 7.65	-9.60/-13.29 -	37.38 22.52	-44/9.44 -	47.90 32.52	14.67/34.22 -	55.39 38.61	14.16/32.68 -	57.19 40.51	16.73/35.34 -
6	ParkScene	4.70 2.89	-6.95/-10.72 -	18.69 16.28	5.94/.17 -	21.38 19.41	17.72/10.76 -	29.60 26.07	20.94/12.81 -	31.55 28.45	24.83/15.84 -
<b>Average</b>		<b>5.02</b> <b>3.38</b>	<b>-5.32/-7.96</b> -	<b>17.79</b> <b>15.49</b>	<b>4.52/6.95</b> -	<b>22.39</b> <b>20.58</b>	<b>18.79/24.33</b> -	<b>27.85</b> <b>25.33</b>	<b>20.83/25.91</b> -	<b>30.22</b> <b>27.74</b>	<b>24.99/29.09</b> -

As can be observed for HD1080p 8 bit content in VBR based coding from Table 5A, average luma PSNR based BD rate percentage difference of MSS HEVC Software Encoder over HM16.18 is 5.0%, 17.8%, 22.4%, 27.9%, and 30.2% higher respectively for TU1, TU4, TU5, TU6, and TU7 modes. This means that for HD1080p test set, for MSS HEVC Software Encoder in VBR based coding to achieve the same luma PSNR quality as HM16.18 requires in TU1 mode 5.0% more bitrate as HM16.18, in TU4 mode 17.8% higher bitrate than HM16.18, in TU5 mode 22.4% higher bitrate than HM16.18, in TU6 mode 27.9% higher bitrate than HM16.18, and in TU7 mode 30.2% higher bitrate than HM16.18.

Further for HD1080p test set in VBR based coding from Table 5A also shows that the average luma MS-SSIM based BD rate percentage difference of MSS HEVC Software Encoder over HM16.18 is 3.4%, 15.5%, 20.6%, 25.3%, and 27.7% higher respectively in TU1, TU4, TU5, TU6, and TU7 modes. This means that for HD1080p test set, the MSS HEVC Software Encoder to achieve the same luma PSNR quality as HM16.18 requires in TU1 mode nearly 3.4% more bitrate than HM16.18, in TU4 mode 15.5% higher bitrate than HM16.18, in TU5 mode 20.6% higher bitrate than HM16.18, in TU6 mode 25.3% higher bitrate than HM16.18 in TU6, and in TU7 mode 27.7% higher bitrate than HM16.18. For HD1080p, in terms of comparing BD rate based on PSNR vs BD rate based on MS-SSIM, BD rate value based on MS-SSIM seems to be around 2-3% less for each TU's than the BD rate based on PSNR.

Table 5B shows for VBR based coding the measured BD rate based on PSNR as percentage (for luma, and chroma components), and BD rate based on MS-SSIM as percentage (for luma component) for each of for each test sequence of HD1080p test set shown in Table 1A for each of 4 TU modes (TU4-GAcc, TU5-GAcc, TU6-GAcc, TU7-GAcc) being evaluated.

Table 5B Quality comparison of **MSS HEVC GACC Encoder** at various target usage (TU) settings with **MPEG HEVC HM 16.18 Encoder** on **HD1080p 8 bit** test set for variable bitrate (VBR) based encoding. Two quality comparison metrics **BD rate** based on **PSNR** of luma and chroma, and **BD rate** based on **MS-SSIM** of luma are employed.

HD1080p 8 bit Test Set	TU4-GAcc VBR		TU5-GAcc VBR		TU6-GAcc VBR		TU7-GAcc VBR	
	% BD rate based on PSNR/MS-SSIM		% BD rate based on PSNR/MS-SSIM		% BD rate based on PSNR/MS-SSIM		% BD rate based on PSNR/MS-SSIM	
	Y	U/V	Y	U/V	Y	U/V	Y	U/V
1 Park_joy	9.73	4.00/1.26	12.38	16.45/16.30	15.80	20.77/19.81	17.89	26.49/23.0
	2.78	-	5.99	-	7.42	-	9.84	-
2 Ducks_take_off	10.07	-6.76/1.12	12.68	1.36/12.91	13.35	3.49/16.49	16.09	9.82/20.47
	9.61	-	12.13	-	10.97	-	13.98	-
3 CrowdRun	16.65	13.82/15.46	19.94	32.21/34.44	24.09	38.84/41.95	26.18	44.58/48.03
	7.73	-	11.33	-	13.57	-	15.27	-
4 TouchDownPass	15.44	9.80/15.86	20.32	34.73/43.01	26.76	42.03/51.14	28.87	46.79/55.7
	18.33	-	25.47	-	30.36	-	32.52	-
5 BQTerrace	41.85	-3.12/8.21	52.18	15.29/36.66	56.85	16.75/39.65	58.66	20.02/43.38
	20.65	-	31.21	-	33.74	-	35.60	-
6 ParkScene	20.56	7.91/1.53	23.57	20.16/12.73	30.48	28.04/19.28	32.66	32.24/22.98
	15.49	-	19.25	-	23.85	-	26.11	-
<b>Average</b>	<b>19.05</b>	<b>4.28/7.07</b>	<b>23.51</b>	<b>20.03/26.01</b>	<b>27.89</b>	<b>24.99/31.39</b>	<b>30.06</b>	<b>29.99/35.61</b>
	<b>12.43</b>	<b>-</b>	<b>17.56</b>	<b>-</b>	<b>19.99</b>	<b>-</b>	<b>22.22</b>	<b>-</b>

As can be observed for HD1080p 8 bit content for VBR based coding from Table 5B, average luma PSNR based BD rate percentage difference of MSS HEVC GAcc Encoder over HM16.18 is 19.1%, 23.5%, 27.9%, and 30.1% higher respectively for TU4-GAcc, TU5-GAcc, TU6-GAcc, and TU7-GAcc modes. This means that for HD1080p test set, for MSS HEVC GAcc Encoder in VBR based coding to achieve the same luma PSNR quality as HM16.18 requires in TU4-GAcc mode 19.1% higher bitrate than HM16.18, in TU5-GAcc mode 23.5% higher bitrate than HM16.18, in TU6-GAcc mode 27.9% higher bitrate than HM16.18, and in TU7-GAcc mode 30.1% higher bitrate than HM16.18. These PSNR based quality numbers for MSS HEVC GAcc Encoder are almost the same as the numbers of MSS HEVC Software Encoder.

Again, for HD1080p test set undergoing VBR coding, Table 5B also shows that the average luma MS-SSIM based BD rate percentage difference of MSS HEVC Software Encoder over HM16.18 is 12.4%, 17.6%, 20.0%, and 22.2% higher respectively in TU4-GAcc, TU5-GAcc, TU6-GAcc, and TU7-GAcc modes. This means that for HD1080p test set, the MSS HEVC Software Encoder to achieve the same luma MS-SSIM quality as HM16.18 requires in TU4-GAcc mode 12.4% higher bitrate than HM16.18, in TU5-GAcc mode 17.6% higher bitrate than HM16.18, in TU6-GAcc mode 20.0% higher bitrate than HM16.18, and in TU7-GAcc mode 22.2% higher bitrate

\*Other names and brands may be claimed as property of others.

than HM16.18. For HD1080p, in terms of comparing BD rate based on PSNR vs BD rate based on MS-SSIM, BD rate value based on MS-SSIM seems to be around 6-9% less for each TU's than the BD rate based on PSNR.

Table 6A shows for AVBR based coding the measured BD rate based on PSNR as percentage (for luma, and chroma components), and BD rate based on MS-SSIM as percentage (for luma component) for each of for each test sequence of HD1080p test set shown in Table 1A for each of 5 TU modes (TU1, TU4, TU5, TU6, TU7) being evaluated.

Table 6A Quality comparison of **MSS HEVC Software Encoder** at various target usage (TU) settings with **MPEG HEVC HM 16.18 Encoder** on **HD1080p 8 bit** test set for adaptive variable bitrate (AVBR) based encoding. Two quality comparison metrics **BD rate** based on **PSNR** of luma and chroma, and **BD rate** based on **MS-SSIM** of luma are employed.

HD1080p 8 bit Test Set	TU1 AVBR		TU4 AVBR		TU5 AVBR		TU6 AVBR		TU7 AVBR	
	% BD Rate based on PSNR/MS-SSIM		% BD Rate based on PSNR/MS-SSIM		% BD Rate based on PSNR/MS-SSIM		% BD Rate based on PSNR/MS-SSIM		% BD Rate based on PSNR/MS-SSIM	
	Y	U/V	Y	U/V	Y	U/V	Y	U/V	Y	U/V
1 Park_joy	2.52	8.80/33	12.22	13.17/14.50	16.26	26.99/33.11	18.85	28.50/33.37	21.09	33.40/35.37
	-0.86	-	10.50	-	15.52	-	17.96	-	20.16	-
2 Ducks_take_off	2.54	7.60/10.20	8.95	1.48/14.82	12.45	9.36/29.49	13.07	11.67/31.92	16.19	18.26/34.93
	3.15	-	9.66	-	13.94	-	14.18	-	17.60	-
3 CrowdRun	3.67	4.28/4.49	16.14	25.90/27.16	21.28	40.65/42.31	27.58	44.26/46.14	29.78	48.34/50.24
	-0.40	-	12.78	-	17.78	-	23.42	-	25.64	-
4 TouchDownPass	1.68	-2.78/-1.78	15.37	20.04/22.34	21.05	44.18/45.73	26.79	47.97/48.98	30.21	54.67/55.55
	5.35	-	18.47	-	26.47	-	31.83	-	34.34	-
5 BQTerrace	6.22	-15.13/-20.72	25.44	-7.21/-.03	35.30	8.67/22.82	42.04	8.65/22.34	43.54	11.15/23.76
	-2.04	-	13.08	-	22.39	-	27.92	-	30.20	-
6 ParkScene	3.68	-5.69/-9.14	18.35	8.88/2.36	21.97	22.04/14.45	29.91	26.18/17.24	31.93	29.85/19.78
	0.70	-	15.22	-	19.01	-	25.73	-	28.12	-
Average	3.38	-4.9/-2.77	16.08	10.38/13.53	21.39	25.32/31.32	26.37	27.87/33.33	28.79	32.61/36.61
	0.98	-	13.28	-	19.19	-	23.51	-	26.01	-

As can be observed for HD1080p 8 bit content in AVBR based coding from Table 6A, average luma PSNR based BD rate percentage difference of MSS HEVC Software Encoder over HM16.18 is 3.4%, 16.1%, 21.4%, 26.4%, and 28.8% higher respectively for TU1, TU4, TU5, TU6, and TU7 modes. This means that for HD1080p test set, for MSS HEVC Software Encoder in AVBR based coding to achieve the same luma PSNR quality as HM16.18 requires in TU1 mode 3.4% more bitrate as HM16.18, in TU4 mode 16.1% higher bitrate than HM16.18, in TU5 mode 21.4% higher bitrate than HM16.18, in TU6 mode 26.4% higher bitrate than HM16.18, and in TU7 mode 28.8% higher bitrate than HM16.18.

Further for HD1080p test set in AVBR based coding from Table 6A also shows that the average luma MS-SSIM based BD rate percentage difference of MSS HEVC Software Encoder over HM16.18 is 1.0%, 13.3%, 19.2%, 23.5%, and 26.0% higher respectively in TU1, TU4, TU5, TU6, and TU7 modes. This means that for HD1080p test set, the MSS HEVC Software Encoder to achieve the same luma PSNR quality as HM16.18 requires in TU1 mode nearly 1% more bitrate than HM16.18, in TU4 mode 13.3% higher bitrate than HM16.18, in TU5 mode 29.2% higher bitrate than HM16.18, in TU6 mode 23.5% higher bitrate than HM16.18 in TU6, and in TU7 mode 26.0% higher bitrate than HM16.18. For HD1080p, in terms of comparing BD rate based on PSNR vs BD rate based on MS-SSIM, BD rate value based on MS-SSIM seems to be around 2-3% less for each TU's than the BD rate based on PSNR.

Table 6B shows for AVBR based coding the measured BD rate based on PSNR as percentage (for luma, and chroma components), and BD rate based on MS-SSIM as percentage (for luma component) for each of for each test sequence of HD1080p test set shown in Table 1A for each of 4 TU modes (TU4-GAcc, TU5-GAcc, TU6-GAcc, TU7-GAcc) being evaluated.

Table 6B Quality comparison of **MSS HEVC GACC Encoder** at various target usage (TU) settings with **MPEG HEVC HM 16.18 Encoder** on **HD1080p 8 bit** test set for adaptive variable bitrate (AVBR) based encoding. Two quality comparison metrics **BD rate** based on **PSNR** of luma and chroma, and **BD rate** based on **MS-SSIM** of luma are employed.

HD1080p 8 bit Test Set	TU4-GAcc AVBR		TU5-GAcc AVBR		TU6-GAcc AVBR		TU7-GAcc AVBR	
	% BD rate based on PSNR/MS-SSIM		% BD rate based on PSNR/MS-SSIM		% BD rate based on PSNR/MS-SSIM		% BD rate based on PSNR/MS-SSIM	
	Y	U/V	Y	U/V	Y	U/V	Y	U/V
1 Park_joy	12.05	14.60/15.55	16.31	29.52/34.31	19.77	35.21/39.06	22.24	41.13/42.27
	5.28	-	9.67	-	10.82	-	13.27	-
2 Ducks_take_off	10.90	1.60/14.73	14.56	10.24/29.85	15.25	13.01/34.15	17.90	20.02/38.14
	6.55	-	10.96	-	9.73	-	12.79	-
3 CrowdRun	17.72	26.74/27.99	22.63	45.08/46.58	27.31	51.87/54.28	29.41	56.53/59.14
	11.29	-	16.16	-	18.92	-	20.96	-
4 TouchDownPass	13.50	16.65/20.66	18.57	44.43/46.68	26.01	55.14/57.49	28.20	61.14/63.70
	13.49	-	20.58	-	25.99	-	27.46	-
5 BQTerrace	29.15	-9.00/-1.72	39.35	8.75/21.95	45.01	11.29/29.34	45.90	13.22/28.83
	10.76	-	21.56	-	26.18	-	27.07	-
6 ParkScene	20.13	10.16/3.04	23.74	23.88/15.72	31.45	32.19/22.79	33.81	37.03/26.65
	14.17	-	18.12	-	23.84	-	26.48	-
<b>Average</b>	<b>17.24</b>	<b>10.13/13.38</b>	<b>22.53</b>	<b>26.98/32.51</b>	<b>27.47</b>	<b>33.12/39.52</b>	<b>29.58</b>	<b>38.18/43.12</b>
	<b>10.26</b>	<b>-</b>	<b>16.17</b>	<b>-</b>	<b>19.25</b>	<b>-</b>	<b>21.34</b>	<b>-</b>

\*Other names and brands may be claimed as property of others.



As can be observed for HD1080p 8 bit content for AVBR based coding from Table 6B, average luma PSNR based BD rate percentage difference of MSS HEVC GAcc Encoder over HM16.18 is 17.2%, 22.5%, 27.5%, and 29.6% higher respectively for TU4-GAcc, TU5-GAcc, TU6-GAcc, and TU7-GAcc modes. This means that for HD1080p test set, for MSS HEVC GAcc Encoder in VBR based coding to achieve the same luma PSNR quality as HM16.18 requires in TU4-GAcc mode 17.2% higher bitrate than HM16.18, in TU5-GAcc mode 22.5% higher bitrate than HM16.18, in TU6-GAcc mode 27.5% higher bitrate than HM16.18, and in TU7-GAcc mode 29.6% higher bitrate than HM16.18. These PSNR based quality numbers for MSS HEVC GAcc Encoder are almost the same as the numbers of MSS HEVC Software Encoder.

Again, for HD1080p test set undergoing AVBR coding, Table 6B also shows that the average luma MS-SSIM based BD rate percentage difference of MSS HEVC Software Encoder over HM16.18 is 10.3%, 16.2%, 19.3%, and 21.3% higher respectively in TU4-GAcc, TU5-GAcc, TU6-GAcc, and TU7-GAcc modes. This means that for HD1080p test set, the MSS HEVC Software Encoder to achieve the same luma MS-SSIM quality as HM16.18 requires in TU4-GAcc mode 10.3% higher bitrate than HM16.18, in TU5-GAcc mode 16.2% higher bitrate than HM16.18, in TU6-GAcc mode 29.3% higher bitrate than HM16.18, and in TU7-GAcc mode 21.3% higher bitrate than HM16.18. For HD1080p, in terms of comparing BD rate based on PSNR vs BD rate based on MS-SSIM, BD rate value based on MS-SSIM seems to be around 6-8% less for each TU's than the BD rate based on PSNR.

Next, Table 7 summarizes the results of CQp and all BRC Modes for various TU settings of MSS HEVC Software and MSS HEVC GAcc Encoder.

Table 7 Summary of quality comparison of **MSS HEVC Software Encoder**, and **MSS HEVC GACC Encoder** at various target usage (TU) settings with **MPEG HEVC HM 16.18 Encoder** on **HD1080p 8 bit** test set for CQp/various bitrate control settings for encoding. Quality metrics employed are **BD rate** based on **PSNR** and **BD rate** based on **MS-SSIM**.

BRC	SW/GAcc	TU1		TU4/TU4-GAcc		TU5/TU5-GAcc		TU6/TU6-GAcc		TU7/TU7-GAcc	
		% BD Rate based on PSNR/MS-SSIM		% BD Rate based on PSNR/MS-SSIM		% BD Rate based on PSNR/MS-SSIM		% BD Rate based on PSNR/MS-SSIM		% BD Rate based on PSNR/MS-SSIM	
		Y	U/V	Y	U/V	Y	U/V	Y	U/V	Y	U/V
1	CQp SW	1.53	-4.05/-5.91	14.69	6.99/9.60	19.46	21.89/27.35	25.08	24.14/28.99	27.31	28.49/32.03
		0.43	-	13.19	-	18.83	-	23.68	-	25.87	-
2	CQp GAcc			15.13	5.56/8.33	19.73	21.18/26.98	24.37	26.42/32.96	26.36	31.24/36.45
				13.54	-	19.25	-	21.55	-	23.59	-
3	CBR SW	5.38	-5.49/-7.97	18.25	4.38/7.12	22.67	18.39/23.97	28.21	20.28/25.31	30.61	24.53/28.53
		3.41	-	15.58	-	20.30	-	25.14	-	27.64	-
4	CBR GAcc			19.45	4.10/6.96	23.90	19.50/25.62	28.23	24.31/30.78	30.30	29.20/34.58
				12.28	-	17.35	-	19.83	-	21.86	-

5	VBR	SW	5.02	-5.32/-7.96	17.79	4.52/6.95	22.39	18.79/24.33	27.85	20.83/25.91	30.22	24.99/29.09
			3.38	-	15.49	-	20.58	-	25.33	-	27.74	-
6	VBR	GAcc			19.05	4.28/7.07	23.51	20.03/26.01	27.89	24.99/31.39	30.06	29.99/35.61
					12.43	-	17.56	-	19.99	-	22.22	-
7	AVBR	SW	3.38	-.49/-2.77	16.08	10.38/13.53	21.39	25.32/31.32	26.37	27.87/33.33	28.79	32.61/36.61
			0.98	-	13.28	-	19.19	-	23.51	-	26.01	-
8	AVBR	GAcc			17.24	10.13/13.38	22.53	26.98/32.51	27.47	33.12/39.52	29.58	38.18/43.12
					10.26	-	16.17	-	19.25	-	21.34	-

Now that we have completed quality analysis on HD1080p 8-bit content of MSS HEVC Software, and GAcc Encoders at various TU settings for CQp/various BRC modes, the next obvious step is to perform analysis of encoding speed offered by each of these modes; this issue is discussed at length in the next section.

## Intel® Media Server Studio HEVC Encoder Quality vs Performance for HD1080p 8-bit

For measurement of encoding speed (fps) and speed vs quality tradeoffs, several recently released PC platform based reference test systems are employed.

In Table S we list a number of recent processor and graphics systems that were used as test systems for performing the evaluation

Table S System configurations (cfg) used in our Tests

cfg	System	Family	Class	Number of Cores	Base CPU Speed GHz	Memory (DRAM) GB	Graphi cs%	Base Graphics Speed MHz
1	i7-6970HQ	SkyLake	Mobile	4	2.8	16	GT4e	350
2	i7-6700K	SkyLake	Desktop	4	4.0	16	GT2	350
3	E3-1275v5	SkyLake	Server	4	3.6	32	GT2	300
4	i7-8700K	CoffeeLake	Workstation	6	3.7	16	GT2	350

% Note that the graphics type, ie, GT2, GT3, or GT4 implicitly indicates the number of execution units (EUs) supported on the system. For instance, GT4 is more capable than GT3 which is more capable than GT2 in terms of number of graphics processing capability (measured in EUs).

All systems employed use 16 GBytes of DRAM, except for E3-1275v5 that had 32 GB.

Each system employed had Microsoft Win 10 Enterprise OS.

Each system employed was run in a the performance (turbo) mode.

\*Other names and brands may be claimed as property of others.

## Performance on **cfg1** of MSS HEVC Software, and GAcc Encoders on HD1080p 8-bit

For encoding of HD1080p 8 bit content on test system **cfg1**, we measure encoding speed (fps) of MPEG HEVC HM16.18 Encoder, as well as our MSS HEVC Software Encoder on a number of TU settings. Results of these measurements comparing the two speeds are shown in Tables 8A and Table 8B.

As can be seen from Table 8A, for MSS HEVC Software Encoder, average encoding speed for HD1080p on test system **cfg1** is 1.5, 11.3, 20.2, 33.6, and 37.6 fps respectively in TU1, TU4, TU5, TU6, and TU7 modes.

Table 8A Average **Encoding Speed** performance (frames per second, **fps**) of **MSS HEVC Software Encoder** at various target usage (**TU**) settings on **HD1080p 8 bit** test set for constant Qp (**CQP**) based encoding; results are for test system (CPU/GPU) configuration 1 (**cfg1**). For reference the average Speed of HM16.18 Encoder for this test set is .030 fps.

HD1080p 8 bit Test Set	TU1	TU4	TU5	TU6	TU7
	Enc Speed (cfg1)	Enc Speed (cfg1)	Enc Speed (cfg1)	Enc Speed (cfg1)	Enc Speed (cfg1)
	fps	fps	fps	fps	fps
1 Park_joy	0.98	7.41	13.60	20.20	22.94
2 Ducks_take_off	0.85	6.71	12.98	20.97	24.10
3 CrowdRun	0.93	8.18	14.40	23.82	26.75
4 TouchDownPass	1.50	14.61	26.38	42.65	47.88
5 BQTerrace	2.89	17.51	30.90	55.28	61.18
6 ParkScene	1.70	13.61	22.99	38.44	42.68
<b>Average</b>	<b>1.47</b>	<b>11.34</b>	<b>20.21</b>	<b>33.56</b>	<b>37.59</b>

Likewise, from Table 8B, for MSS HEVC GAcc Encoder, average encoding speed for HD1080p on test system **cfg1** is 21.0, 34.2, 53.7, and 59.5 fps respectively in TU4-GAcc, TU5-GAcc, TU6-GAcc, and TU7-GAcc modes.

Table 8B Average **Encoding Speed** performance (**fps**) of **MSS HEVC GAcc Encoder** at various target usage (**TU**) settings on **HD1080p 8 bit** test set for constant Qp (**CQP**) based encoding; results are for test system (CPU/GPU) configuration 1 (**cfg1**). For reference the average Speed of HM16.18 Encoder for this test set is .030 fps.

HD1080p 8 bit Test Set	TU4-GAcc	TU5-GAcc	TU6-GAcc	TU7-GAcc
	Enc Speed (cfg1)	Enc Speed (cfg1)	Enc Speed (cfg1)	Enc Speed (cfg1)
	fps	fps	fps	fps
1 Park_joy	12.22	22.52	37.24	42.37
2 Ducks_take_off	10.73	21.73	38.99	44.90
3 CrowdRun	13.91	22.62	39.72	44.28
4 TouchDownPass	29.67	46.81	70.16	77.16
5 BQTerrace	35.14	53.34	75.53	81.91

6 ParkScene	24.14	38.30	60.48	66.40
<b>Average</b>	<b>20.97</b>	<b>34.22</b>	<b>53.69</b>	<b>59.50</b>

## Performance on **cfg2** of MSS HEVC Software, and GAcc Encoders on HD1080p 8-bit

For encoding of HD1080p 8 bit content on test system **cfg2**, we measure encoding speed (fps) of MPEG HEVC HM16.18 Encoder, as well as our MSS HEVC Software Encoder on a number of TU settings. Results of these measurements comparing the two speeds are shown in Tables 8C and Table 8D.

From Table 8C, for MSS HEVC Software Encoder, average encoding speed for HD1080p on test system **cfg2** is 2.7, 18.3, 32.6, 53.9, and 59.4 fps respectively in TU1, TU4, TU5, TU6, and TU7 modes.

Table 8C Average **Encoding Speed** performance (fps) of **MSS HEVC Software Encoder** at various target usage (TU) settings on **HD1080p 8 bit** test set for constant Qp (**CQP**) based encoding; results are for test system (CPU/GPU) configuration 2 (**cfg2**). For reference the average Speed of HM16.18 Encoder for this test set is .030 fps.

HD1080p 8 bit Test Set	TU1	TU4	TU5	TU6	TU7
	Enc Speed (cfg2)	Enc Speed (cfg2)	Enc Speed (cfg2)	Enc Speed (cfg2)	Enc Speed (cfg2)
	fps	fps	fps	fps	fps
1 Park_joy	1.90	13.06	23.42	34.97	39.08
2 Ducks_take_off	1.53	11.20	21.27	33.97	38.60
3 CrowdRun	1.70	13.59	23.71	38.80	42.93
4 TouchDownPass	2.72	22.82	41.47	66.98	73.89
5 BQTerrace	5.33	27.28	48.83	86.94	94.70
6 ParkScene	3.06	21.64	36.79	61.45	66.99
<b>Average</b>	<b>2.71</b>	<b>18.26</b>	<b>32.58</b>	<b>53.85</b>	<b>59.36</b>

Next, from Table 8D, for MSS HEVC GAcc Encoder, average encoding speed for HD1080p on test system **cfg2** is 29.1, 45.6, 76.6, and 82.7 fps respectively in TU4-GAcc, TU5-GAcc, TU6-GAcc, and TU7-GAcc modes.

Table 8D Average **Encoding Speed** performance (fps) of **MSS HEVC GAcc Encoder** at various target usage (TU) settings on **HD1080p 8 bit** test set for constant Qp (**CQP**) based encoding; results are for test system (CPU/GPU) configuration 2 (**cfg2**). For reference the average Speed of HM16.18 Encoder for this test set is .030 fps.

HD1080p 8 bit Test Set	TU4-GAcc	TU5-GAcc	TU6-GAcc	TU7-GAcc
	Enc Speed (cfg2)	Enc Speed (cfg2)	Enc Speed (cfg2)	Enc Speed (cfg2)
	fps	fps	fps	fps
1 Park_joy	19.28	33.92	58.42	64.65
2 Ducks_take_off	16.49	31.51	59.59	66.64
3 CrowdRun	21.47	35.83	64.47	70.30
4 TouchDownPass	39.12	57.68	94.31	100.80

\*Other names and brands may be claimed as property of others.

5	BQTerrace	44.57	63.89	99.97	105.23
6	ParkScene	33.60	50.79	83.01	88.39
<b>Average</b>		<b>29.09</b>	<b>45.60</b>	<b>76.63</b>	<b>82.67</b>

## Performance on **cfg3** of MSS HEVC Software, and GAcc Encoders on HD1080p 8-bit

For encoding of HD1080p 8 bit content on test system **cfg3**, we measure encoding speed (fps) of MPEG HEVC HM16.18 Encoder, as well as our MSS HEVC Software Encoder on a number of TU settings. Results of these measurements comparing the two speeds are shown in Tables 8E and Table 8F.

From Table 8E, for MSS HEVC Software Encoder, average encoding speed for HD1080p on test system **cfg3** is 2.6, 18.0, 31.8, 52.7, and 58.2 fps respectively in TU1, TU4, TU5, TU6, and TU7 modes.

Table 8E Average **Encoding Speed** performance (fps) of **MSS HEVC Software Encoder** at various target usage (TU) settings on **HD1080p 8 bit** test set for constant Qp (CQP) based encoding; results are for test system (CPU/GPU) configuration 3 (**cfg3**). For reference the average Speed of HM16.18 Encoder for this test set is .030 fps.

HD1080p 8 bit Test Set	TU1	TU4	TU5	TU6	TU7
	Enc Speed (cfg3)	Enc Speed (cfg3)	Enc Speed (cfg3)	Enc Speed (cfg3)	Enc Speed (cfg3)
	fps	fps	fps	fps	fps
1 Park_joy	1.82	12.86	23.00	33.91	38.07
2 Ducks_take_off	1.45	11.08	21.02	33.07	37.66
3 CrowdRun	1.61	13.40	23.32	37.60	41.55
4 TouchDownPass	2.60	22.70	40.55	65.68	72.65
5 BQTerrace	4.96	26.93	47.45	85.25	92.87
6 ParkScene	2.87	21.01	35.64	60.46	66.50
<b>Average</b>	<b>2.55</b>	<b>18.00</b>	<b>31.83</b>	<b>52.66</b>	<b>58.22</b>

Next, from Table 8F, for MSS HEVC GAcc Encoder, average encoding speed for HD1080p on test system **cfg3** is 29.2, 46.3, 74.0, and 80.5 fps respectively in TU4-GAcc, TU5-GAcc, TU6-GAcc, and TU7-GAcc modes.

Table 8F Average **Encoding Speed** performance (fps) of **MSS HEVC GAcc Encoder** at various target usage (TU) settings on **HD1080p 8 bit** test set for constant Qp (CQP) based encoding; results are for test system (CPU/GPU) configuration 3 (**cfg3**). For reference the average Speed of HM16.18 Encoder for this test set is .030 fps.

HD1080p 8 bit Test Set	TU4-GAcc	TU5-GAcc	TU6-GAcc	TU7-GAcc
	Enc Speed (cfg3)	Enc Speed (cfg3)	Enc Speed (cfg3)	Enc Speed (cfg3)
	fps	fps	fps	fps
1 Park_joy	20.25	32.37	55.61	62.13
2 Ducks_take_off	20.71	32.94	56.85	64.02
3 CrowdRun	22.03	36.39	61.76	67.91

4	TouchDownPass	38.88	60.20	91.31	98.33
5	BQTerrace	37.93	61.99	97.55	103.20
6	ParkScene	35.30	53.97	81.07	87.30
<b>Average</b>		<b>29.18</b>	<b>46.31</b>	<b>74.02</b>	<b>80.48</b>

## Performance on **cfg4** of MSS HEVC Software, and GAcc Encoders on HD1080p 8-bit

For encoding of HD1080p 8 bit content on test system **cfg4**, we measure encoding speed (fps) of MPEG HEVC HM16.18 Encoder, as well as our MSS HEVC Software Encoder on a number of TU settings. Results of these measurements comparing the two speeds are shown in Tables 8G and Table 8H.

From Table 8G, for MSS HEVC Software Encoder, average encoding speed for HD1080p on test system **cfg4** is 3.5, 24.4, 43.8, 69.3, and 75.9 fps respectively in TU1, TU4, TU5, TU6, and TU7 modes.

Table 8G Average **Encoding Speed** performance (fps) of **MSS HEVC Software Encoder** at various target usage (TU) settings on **HD1080p 8 bit** test set for constant Qp (**CQP**) based encoding; results are for test system (CPU/GPU) configuration 4 (**cfg4**). For reference the average Speed of HM16.18 Encoder for this test set is .030 fps.

HD1080p 8 bit Test Set	TU1	TU4	TU5	TU6	TU7	
	Enc Speed (cfg4)	Enc Speed (cfg4)	Enc Speed (cfg4)	Enc Speed (cfg4)	Enc Speed (cfg4)	
	fps	fps	fps	fps	fps	
1	Park_joy	2.54	17.65	32.04	44.88	49.59
2	Ducks_take_off	2.02	14.85	28.73	44.29	50.33
3	CrowdRun	2.20	17.83	31.35	48.76	53.87
4	TouchDownPass	3.64	30.60	55.80	87.05	95.27
5	BQTerrace	6.46	36.50	65.35	109.66	118.45
6	ParkScene	4.03	28.94	49.67	80.89	88.02
<b>Average</b>		<b>3.48</b>	<b>24.39</b>	<b>43.82</b>	<b>69.25</b>	<b>75.92</b>

Likewise, from Table 8H, for MSS HEVC GAcc Encoder, average encoding speed for HD1080p on test system **cfg4** is 31.9, 51.6, 90.9, and 99.1 fps respectively in TU4-GAcc, TU5-GAcc, TU6-GAcc, and TU7-GAcc modes.

Table 8H Average **Encoding Speed** performance (fps) of **MSS HEVC GAcc Encoder** at various target usage (TU) settings on **HD1080p 8 bit** test set for constant Qp (**CQP**) based encoding; results are for test system (CPU/GPU) configuration 4 (**cfg4**). For reference the average Speed of HM16.18 Encoder for this test set is .030 fps.

HD1080p 8 bit Test Set	TU4-GAcc	TU5-GAcc	TU6-GAcc	TU7-GAcc	
	Enc Speed (cfg4)	Enc Speed (cfg4)	Enc Speed (cfg4)	Enc Speed (cfg4)	
	fps	fps	fps	fps	
1	Park_joy	22.58	40.93	70.16	79.20
2	Ducks_take_off	19.84	37.72	72.37	81.99

\*Other names and brands may be claimed as property of others.

3	CrowdRun	25.28	42.76	77.23	85.65
4	TouchDownPass	42.38	63.72	111.74	119.36
5	BQTerrace	45.59	67.24	115.41	121.81
6	ParkScene	35.96	57.30	98.40	106.37
<b>Average</b>		<b>31.94</b>	<b>51.61</b>	<b>90.88</b>	<b>99.07</b>

### Encoding Speed comparison for different cfg's, and TU settings for HD1080p 8-bit

We first summarize in Table 9, results of our tests using different test systems on important TU settings for both MSS HEVC SW, and HEVC GAcc Encoders.

Table 9 Summary of **Encoding Speed** performance comparison of **MSS HEVC Software Encoder**, and **MSS HEVC GACC Encoder** at various target usage (TU) settings for different test system configurations (cfg1, cfg2, cfg4) on HD1080p 8 bit test set for CQP based encoding.

Config SW/GAcc	TU1		TU4/TU4-GAcc		TU5/TU5-GAcc		TU6/TU6-GAcc		TU7/TU7-GAcc	
	Enc Speed		Enc Speed		Enc Speed		Enc Speed		Enc Speed	
	fps		fps		fps		fps		fps	
1	cfg1	SW	1.47	11.34	20.21	33.56	37.59			
2	cfg1	GAcc		20.97	34.22	53.69	59.50			
3	cfg2	SW	2.71	18.26	32.58	53.85	59.36			
4	cfg2	GAcc		29.09	45.60	76.63	82.67			
5	cfg3	SW	2.55	18.00	31.83	52.66	58.22			
6	cfg3	GAcc		29.18	46.31	74.02	80.48			
7	cfg4	SW	3.48	24.39	43.82	69.25	75.92			
8	cfg4	GAcc		31.94	51.61	90.88	99.07			

As can be seen from Table 9, for MSS HEVC Software Encoder, the fastest test system cfg4, can irrespective of the TU provide ~1.3x speedup as compared to the test system cfg2, and almost 2.1x speedup over test system cfg1.

Likewise from the same table, we can also observe that for a particular test system configuration, and TU setting the MSS HEVC GAcc Encoder can typically be 1.4x to 1.6x faster (in some cases, such as for test system cfg1, this factor is as much as 1.7x or even more) than the MSS HEVC Software Encoder. Further, as noted earlier, for a corresponding TU, the video quality/compression generated by the MSS HEVC GAcc Encoder is very similar to that of the MSS HEVC Software Encoder's video quality/compression. This would seem to indicate that the MSS HEVC GAcc Encoder is sufficient, however it would seem to make the MSS HEVC Software Encoder somewhat redundant. In reality, there are a number of reasons that the MSS HEVC Software Encoder is also necessary; these reasons are discussed next.

Also from Table 9 it can be seen that the super-high quality setting TU1 only exists for MSS HEVC Software Encoder (and not for MSS HEVC GAcc Encoder); this has to do with the type of tradeoffs that lend themselves to provide good speedup for MSS HEVC GAcc Encoder, are not the best ones to help achieve super-high quality – for that you need different tradeoff approaches that are best in pure software. There are additional reasons also such that in some environments instead of graphics/GPU, the emphasis is on large number of cores, which means that MSS HEVC GAcc Encoder would not work there and one would need the MSS HEVC Software Encoder.

One other thing to observe is that the fastest combination of test systems, codec, and TU settings allows average encoding speeds of almost 100 fps for 1080p coding.

Fig. 7A shows bar-graphs comparing the performance of each of the key TU modes as well as wrt MPEG HM 16.18 (with its speed also shown on the same figure) of each of the key TU modes of MSS HEVC Software Encoder on test system *cfg2*. Specifically, for 1080p encoding, the average speed of MSS HEVC Software Encoder for TU1, TU4, TU5, TU6, and TU7 is shown respectively to be 2.7 fps, 18.3 fps, 32.6 fps, 53.9 fps, and 59.4 fps.

Further from Fig. 7A it can also be seen that on test system *cfg2* the encoding speed of MSS HEVC Software Encoder wrt HM16.18 encoder for encoding of 1080p content is 90x, 608x, 1086x, 1795x, and 1978x in TU1, TU4, TU5, TU6, and TU7 modes respectively. Thus, encoding at TU1 is 90x, and TU4 – TU7 is in range of 600x to 2000x (multithreaded on 4 cores) the speed of HM16.18 (single threaded/1 core). Earlier we had shown that the quality of TU1 mode is nearly identical (based both PSNR based BD rate, and MS-SSIM based BD rate) to quality of HM16.18.

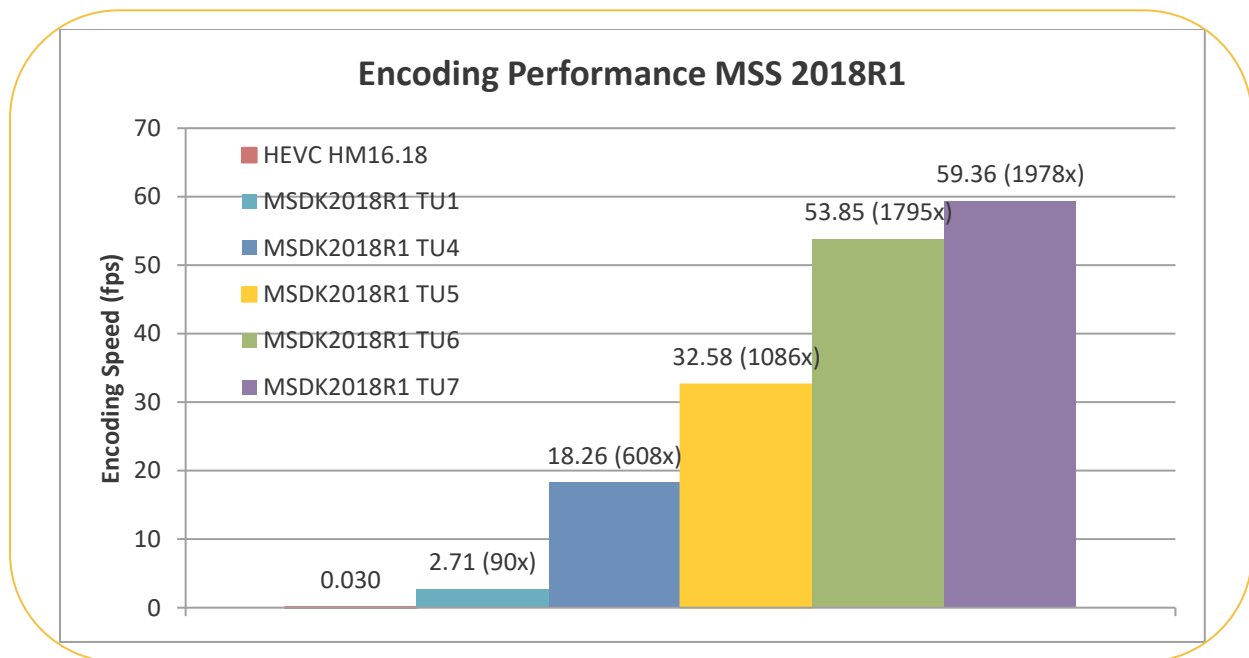

\*Other names and brands may be claimed as property of others.



Figure 7A Average speed of encoding of HM reference, and MSS HEVC Software Encoder for TU settings of TU1, TU4, TU5, TU6, and TU7, for encoding of HD 1080p content on test sytem configuration 2 (cfg2).

Fig. 7B shows bar-graphs comparing the performance of each of the key TU modes as well as wrt MPEG HM 16.18 (with its speed also shown on the same figure) of each of the key TU modes of MSS HEVC GAcc Encoder on test system cfg2. Specifically, for 1080p encoding, the average speed of MSS HEVC GAcc Encoder for TU4, TU5, TU6, and TU7 is shown respectively to be 29.1 fps, 45.6 fps, 76.6 fps, and 59.4 fps.

Further from Fig. 7B it can also be seen that on test system *cfg2* the encoding speed of MSS HEVC GAcc Encoder wrt HM16.18 encoder for encoding of 1080p content is 969x, 1520x, 2554x, and 2755x in TU4-GAcc, TU5-GAcc, TU6-GAcc, and TU7-GAcc modes respectively. Thus, encoding at TU4-GAcc – TU7-GAcc is in range of 900x to 2750x (multithreaded on 4 cores) the speed of HM16.18 (single threaded/1 core). Earlier we had shown that the quality of TU4-GAcc mode is ‘very good’ if not identical to quality of HM16.18.

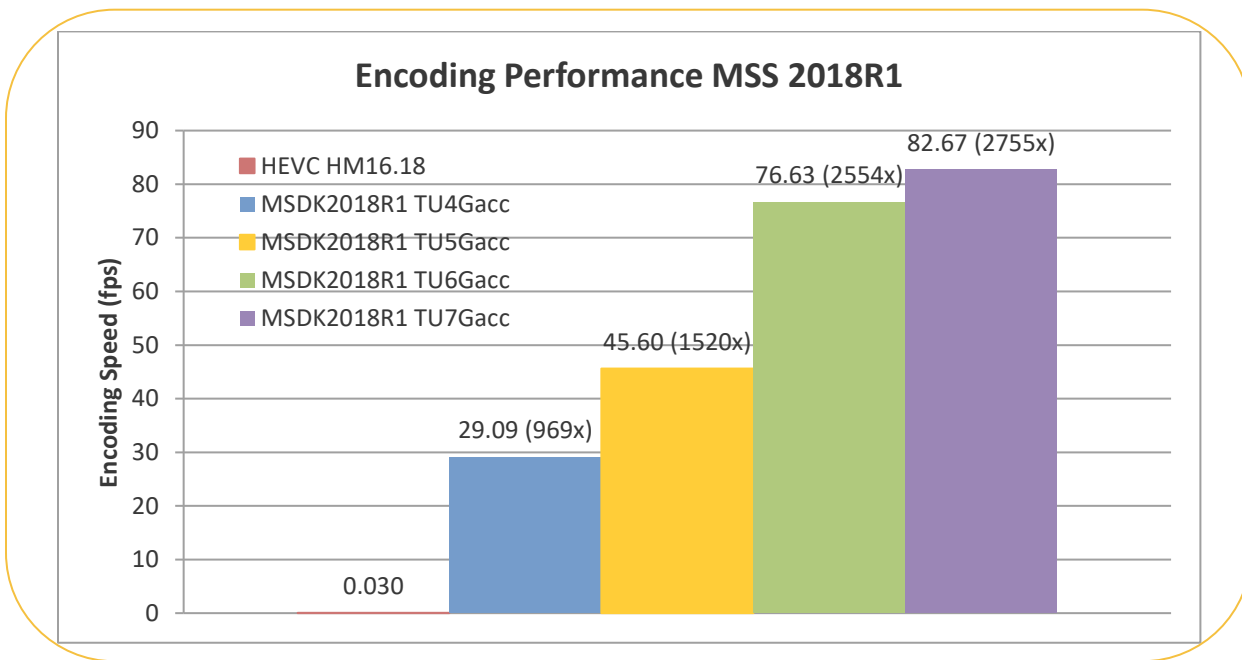

Figure 7B Average speed of encoding of HM reference, and Intel Media Server Studio HEVC GAcc Encoder for TU settings of TU4, TU5, TU6, and TU7, for encoding of HD 1080p content on test system configuration 2 (cfg2).

### CPU Load Comparison of Media Server Studio HEVC Software, and GAcc Encoders on HD1080p 8-bit

We now discuss the issue of CPU load when running HEVC encoding with MSS HEVC Software, and MSS HEVC GAcc Encoders. A high CPU load may suggest that vailable CPU’s are being used effectively, however

if the CPU load is too high, it can also indicate that the system is rather overloaded and unable to perform any other task including system management tasks comfortably.

Fig. 8A shows on test system *cfg2*, the load comparison of MSS HEVC Software, and MSS HEVC GAcc Encoders for various TU settings. Specifically, the CPU load %age of MSS HEVC Software Encoder is shown for TU settings of TU1, TU4, TU5, TU6, and TU7 to be 94.4, 97.1, 98.1, 96.4, and 95.4 respectively. Further, the CPU load %age of MSS HEVC GAcc Encoder is also shown but for TU settings of TU4-GAcc, TU5-GAcc, TU6-GAcc, and TU7-GAcc to be 84.9, 88.5, 91.9, 91.4 respectively. This means that MSS HEVC GAcc Encoder is able to free up CPU load of 5 to 10 %age as compared to MSS HEVC Software Encoder allowing normal system functions to function; this is in addition to MSS HEVC GAcc Encoder being 1.4x to 1.6x faster while at the same quality.

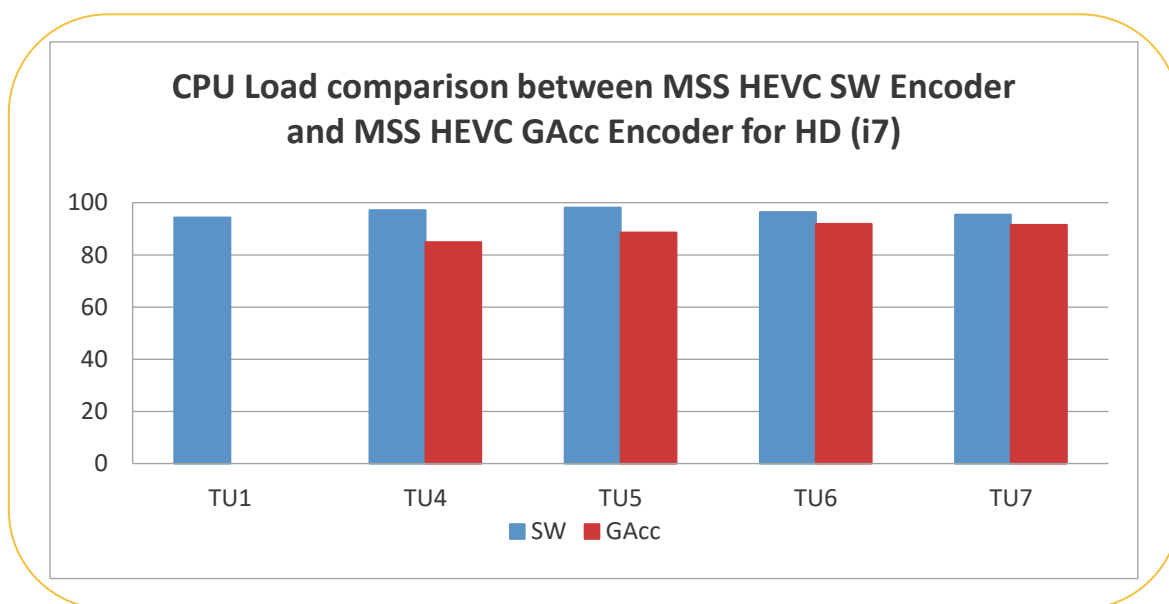

Figure 8A CPU Load Difference in HD1080p encoding between MSS HEVC Software Encoder and MSS HEVC GAcc Encoder at different TU modes on test system configuration 2 (*cfg2*).

Next, Fig. 8B shows a similar load comparison but on test system *cfg4* which has more cores (6) as compared to 4 cores in test system *cfg2*. Here we observe that the CPU load %age is typically lower by 15-20% depending on the TU for MSS HEVC GAcc Encoder over same TU of MSS HEVC Software Encoder.

\*Other names and brands may be claimed as property of others.

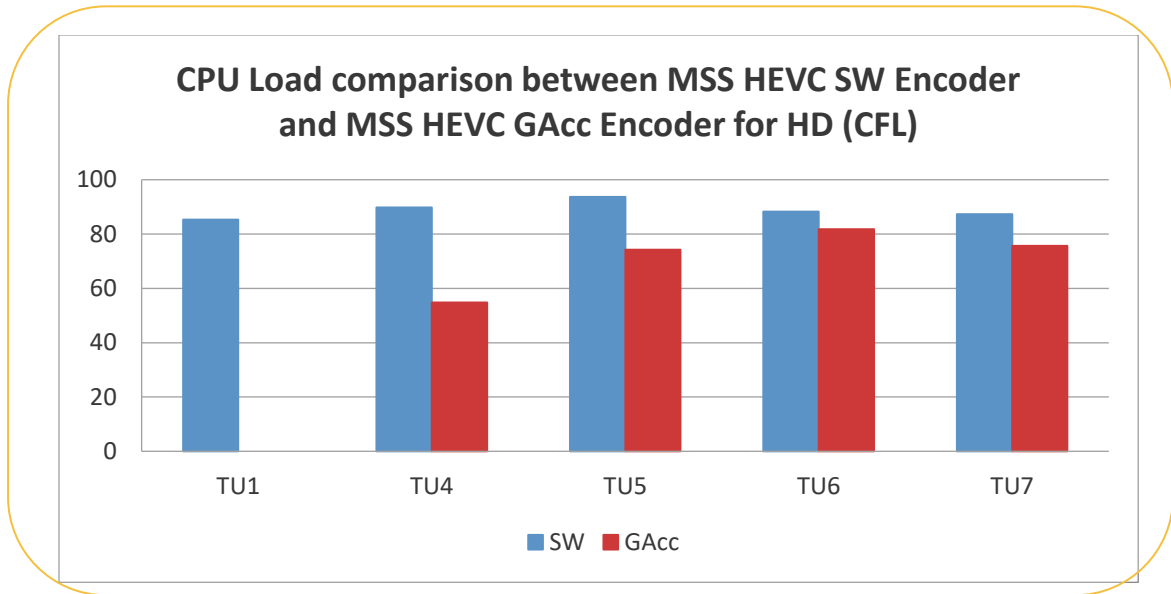

Figure 8B CPU Load Difference in HD1080p encoding between Media Server Studio HEVC Software Encoder and its HEVC GAcc Encoder at different TU modes on test system configuration 4 (cfg4).

## Quality vs Performance of Media Server Studio HEVC Software, and GAcc Encoders on HD1080p 8-bit

We now discuss the overall Codec Quality vs Encoding Performance results for both the MSS HEVC Software, and MSS HEVC GAcc Encoders for various TU settings that they support.

Fig. 9A shows for test system *cfg2*, comparison of Quality in the units of negative Y PSNR based BD rate %age wrt HEVC HM16.18 (smaller is better) vs Encoding Performance (fps) for each of the the five TU settings - TU1, TU4, TU5, TU6, and TU7 for the MSS HEVC Software Encoder and the four TU settings – TU14-GAcc, TU5-GAcc, TU6-GAcc, and TU7-GAcc for the MSS HEVC GAcc Encoder. The y-axis basically shows the quality difference in terms of loss of BD rate percentage difference in the process of increasing speed up of the encoder in going from TU1 to TU4 to TU5 to TU6 to TU7 operating points for MSS HEVC Software Encoder, and TU4-GAcc to TU5-GAcc to TU6-GAcc to TU7-GAcc operating points for MSS HEVC GAcc Encoder. The quality values per TU were obtained from Table 7 whereas the performance values were obtained from Table 9.

From Fig. 9A, we can clearly see that for any given quality corresponding to TU4 and above, the encoding speed provided by MSS HEVC GAcc Encoder is significantly faster than that by MSS HEVC Software Encoder.

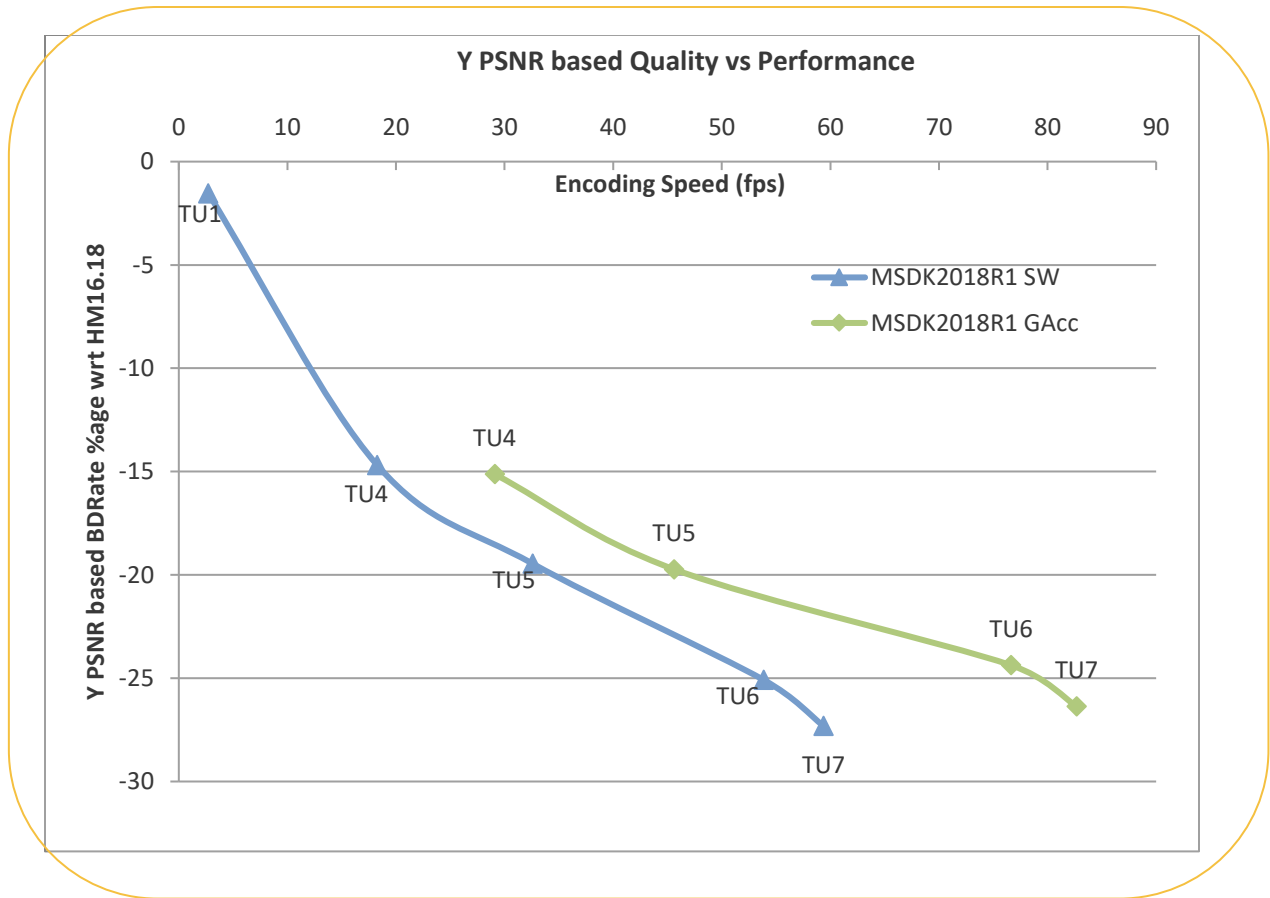

Figure 9A Quality (Y PSNR based BD rate wrt HM16.18) vs Encoding Speed Tradeoff in encoding of HD1080p content by MSS HEVC Software, and MSS HEVC GAcc Encoders in different TU modes, on test system configuration 2 (cfg2)

Fig. 9B similarly shows for test system *cfg2*, comparison of Quality in the units of negative MS-SSIM based BD rate %age wrt HEVC HM16.18 (smaller is better) vs Encoding Performance (fps) for each of the the five TU settings - TU1, TU4, TU5, TU6, and TU7 for the MSS HEVC Software Encoder and the four TU settings – TU14-GAcc, TU5-GAcc, TU6-GAcc, and TU7-GAcc for the MSS HEVC GAcc Encoder. The quality values per TU were obtained from Table 7 whereas the performance values were obtained from Table 9.

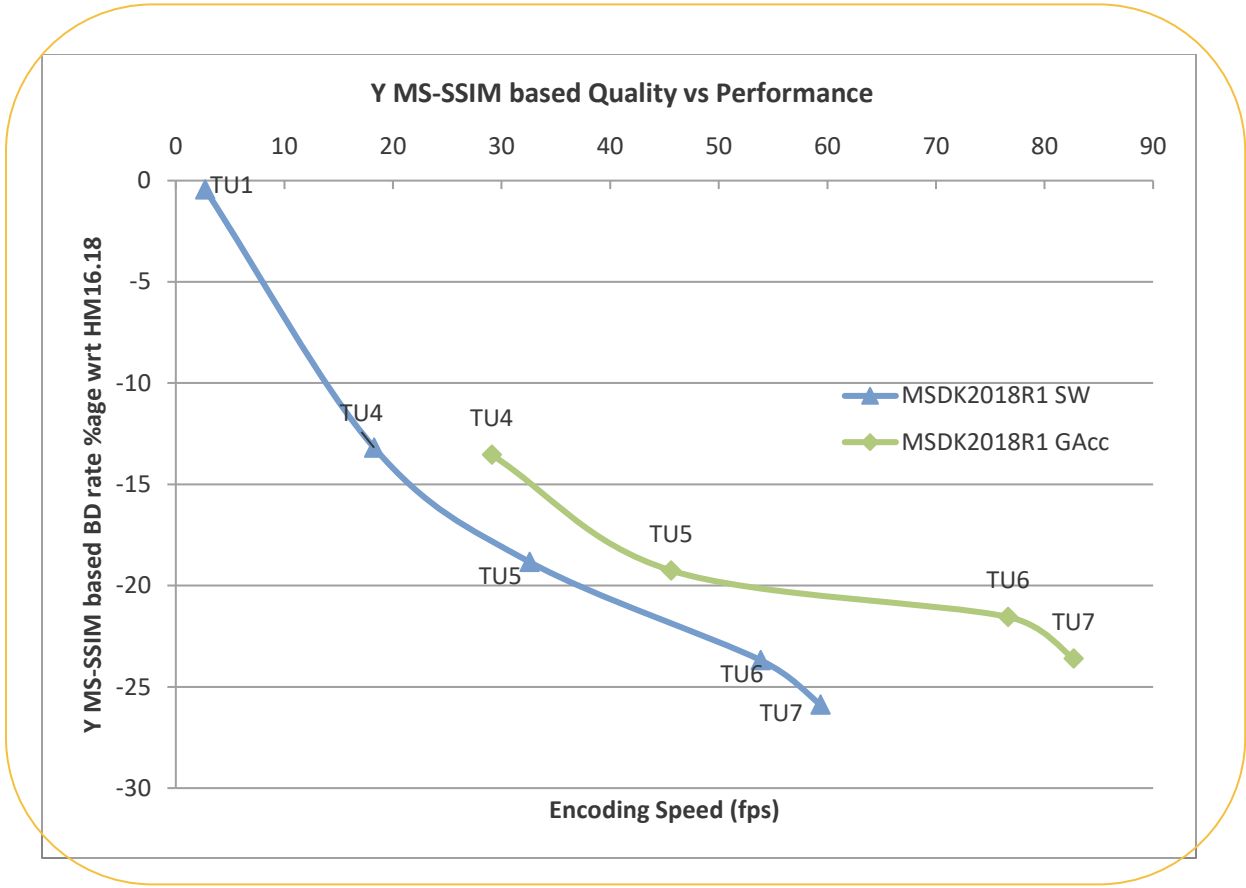

Figure 9B Quality (Y MS-SSIM based BD rate wrt HM16.18) vs Encoding Speed Tradeoff in encoding of HD1080p content by MSS HEVC Software, and MSS HEVC GAcc Encoders in different TU modes, on test system configuration 2 (cfg2)

To summarize, encoding performance-wise MSS HEVC Software, and MSS HEVC GAcc Encoders in different TU modes achieves the following speedup of HEVC encoding on test system cfg2, the 4 core Reference PC platform specified earlier.

- On test system cfg2 and for HD1080p test set, MSS HEVC Software Encoder in TU1, TU4, TU5, TU6, and TU7, correspondingly on average provides 2.7 fps, 18.3 fps, 32.6 fps, 53.9 fps, and 59.4 fps. This reflects for the five TU's corresponding speedup factors wrt HM16.18 of 90, 608, 1086, 1795, and 1978.
- On test system cfg2 and for HD1080p test set, MSS HEVC GAcc Encoder in TU4-GAcc, TU5-GAcc, TU6-GAcc, and TU7-GAcc, correspondingly on average provides 29.1 fps, 45.6 fps, 76.6 fps, and 82.7 fps. This reflects for the four TU's corresponding speedup factors wrt HM16.18 of 969, 1520, 2554, and 2755.

## Intel Media Server Studio HEVC Software Decoder Performance for HD1080p 8-bit

In this section we describe results of performance measurement of decoding by Intel® MSS HEVC Decoder, encoded HD1080p 8 bit bitstreams. For measurement of decoding speed (fps), the same test system cfg2 used for encoding speed measurement, is employed.

The HEVC Software Decoder is able to achieve very high threading throughput consuming over 90% of resources on the noted machine.

For measurement of decoder performance, longer bitstreams of around 1000 or more frames are necessary to obtain a stable measurement. Thus, each of the video sequences of since they are relatively short were extended by palindromic repetition (so as not to introduce sudden scene changes that might introduce an unnatural behavior in the measurement) to 1200 frames long and compressed with MSS HEVC Software or GAcc Encoders using the same Qp quantizers as in Table 1A. These longer compressed streams were then used for decoder performance measurement.

Tables 10A shows for test system cfg2, average bitstream decoding speed for bitstreams generated from encoding each sequence of 1080p test set by MSS HEVC Software Encoder in each of its TU (TU1, TU4, TU5, TU6, TU7) modes.

Table 10A Average **Decoding Speed** performance (fps) of **MSS HEVC Software Decoder** decoding on test system configuration 2 (cfg2), streams of **HD1080p 8 bit** test set encoded at constant Qp (CQP) by **MSS HEVC Software Encoder** in various TU modes.

HD1080p 8 bit Test Set	TU1	TU4	TU5	TU6	TU7
	Dec Speed (cfg2)	Dec Speed (cfg2)	Dec Speed (cfg2)	Dec Speed (cfg2)	Dec Speed (cfg2)
	fps	fps	fps	fps	fps
1 Park_joy	272.78	291.30	304.34	312.57	318.36
2 Ducks_take_off	346.00	362.27	379.64	376.86	383.10
3 CrowdRun	289.00	325.91	338.93	353.93	359.76
4 TouchDownPass	491.58	528.50	551.48	559.85	580.08
5 BQTerrace	491.71	529.64	557.20	563.30	581.80
6 ParkScene	392.31	441.64	450.31	465.26	472.59
<b>Average</b>	<b>380.56</b>	<b>413.21</b>	<b>430.32</b>	<b>438.63</b>	<b>449.28</b>

Tables 10B shows for test system cfg2, average bitstream decoding speed for bitstreams generated from encoding each sequence of 1080p test set by MSS HEVC GAcc Encoder in each of its TU (TU4-GAcc, TU5-GAcc, TU6-GAcc, TU7-GAcc) modes.

Table 10B Average **Decoding Speed** performance (fps) of **MSS HEVC Software Decoder** decoding on test system configuration 2 (cfg2), streams of **HD1080p 8 bit** test set encoded at constant Qp (CQP) by **MSS HEVC GAcc Encoder** in various TU modes.

HD1080p 8 bit Test Set	TU4-GAcc	TU5-GAcc	TU6-GAcc	TU7-GAcc
	Dec Speed (cfg2)	Dec Speed (cfg2)	Dec Speed (cfg2)	Dec Speed (cfg2)
	fps	fps	fps	fps
1 Park_joy	293.95	305.68	311.03	311.02
2 Ducks_take_off	362.20	379.28	374.48	371.90

\*Other names and brands may be claimed as property of others.

3	CrowdRun	330.07	342.50	343.86	343.08
4	TouchDownPass	531.34	546.99	555.54	551.13
5	BQTerrace	545.89	565.03	560.49	560.65
6	ParkScene	445.49	458.07	465.39	457.63
<b>Average</b>		<b>418.16</b>	<b>432.93</b>	<b>435.13</b>	<b>432.57</b>

As can be seen from Table 10A-10B, as expected, the decoding speed to some extent depends on corresponding TU setting used for software or GAcc encoder; in other words, decoding speed is bit slower for lower TU values (such as TU1 or TU4), and higher for higher TU's (such as TU7). However, the difference in decoding speed is not significant for same TU for software and GAcc encoders (such as TU4 and TU4-GAcc). Overall, for test system cfg2, by using maximum benefit of threading, typical decoding speed for HD1080p video is within the range of 375-450 fps.

Fig. 10 shows comparison of decoding performance on test system cfg2 for each of TU encoded bitstreams generated by MSS HEVC Software Encoder.

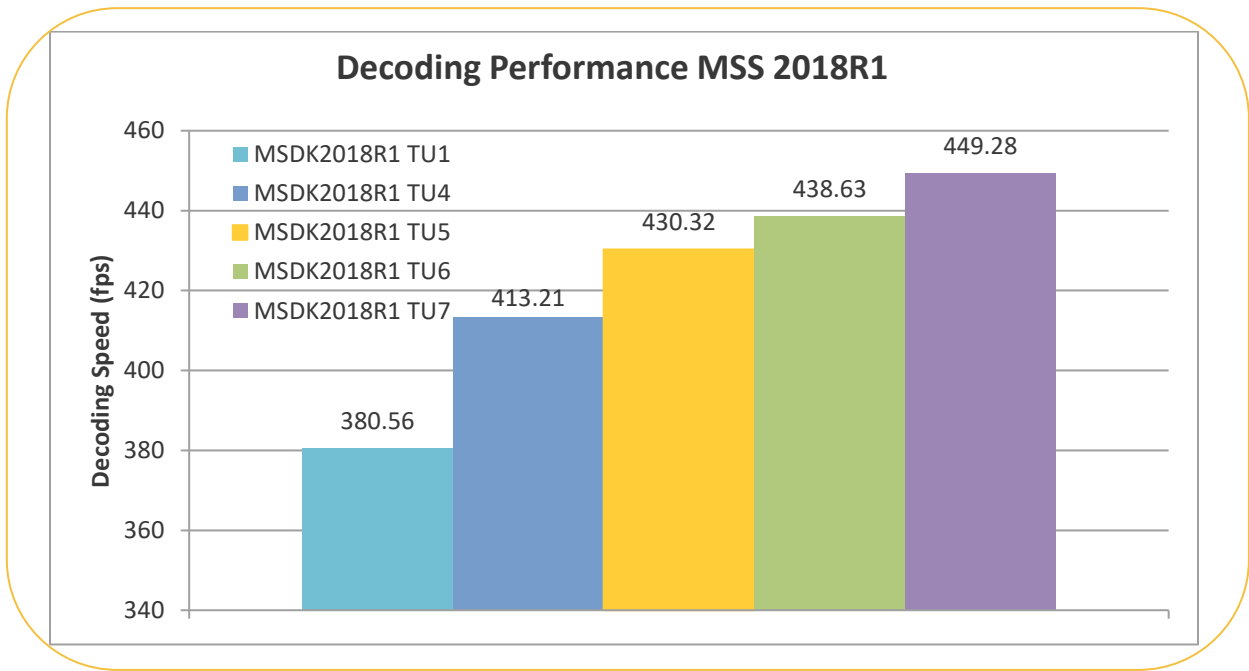

Figure 10 Average decoding speed on test system configuration 2 (cfg2), of of HD1080p content encoded by MSS HEVC Software Encoder for TU settings of TU1, TU4, TU5, TU6, and TU7.

## *Part 2*

# Coding Quality, and Performance in Encoding of Ultra-High Definition (UHD4K) 10-bit content with Intel® Media Server Studio HEVC Software, and Graphics Accelerated (GAcc) Encoders



## Intel Media Server Studio HEVC Software, and GAcc Encoders Quality Evaluation for UHD4K 10-bit video content

In this section, we first describe our general test methodology for evaluating quality of HEVC encoding and then report on comparison of results of detailed quality tests using the aforementioned methodology performed on Media Server Studio HEVC Software, and HEVC GAcc Encoders with respect to MPEG HEVC HM16.18 Encoder. As is well known, the HM Codec is an ideal quality reference codec however it is impractically slow for msot applications.

### Quality Evaluation Test Methodology for UHD4K 10-bit

To measure quality of a coded/decoded image or video with respect to a high quality version of the same image or video used as reference, many objective quality metrics exist such as peak signal-to-noise ratio (PSNR), peak signal-to-noise ratio human visual system (PSNR-HVS), structural similarity index (SSIM), multi scale structural similarity index (MS-SSIM), newer combination metrics such as VMAF (Video Multi Method Assesment Fusion) and others. The goal of non-PSNR based objective metrics is of course to try to approximate as closely as possible how human visual system perceives image or video quality without the need of expensive, subjective quality tests.

In absence of significant consensus on the best objective metric that works well providing good approximation to visual quality as perceived by humans (while also being reasonable in computational costs), and based on our internal study of correlation of VQEG (Video Quality Expert Group's) test data to MOS (man opinion scores), MS-SSIM often offers a resonable approximation of to perceived visual quality. Thus, we use average value of MS-SSIM of a sequence in addition to PSNR of a sequence to fully classify coding quality of an coded sequence. Further, when the goal of the quality measurement is to classify the behaviour of a codec with respect to a reference codec over a range of bit-rates, we combine the above noted quality metrics with a statistically tractable technique curve fitting technique scuh as MPEG BD rate measure descriebd next.

To compare video quality produced by a video codec being tested as compared to a reference codec, rate Distortion (RD) characteristics for both the codecs are computed using each codec's 4-point Quality Metric/Bitrate measurements followed MPEG's new BD rate ([5]) curve fitting procedure that generates a continuous RD curve that tightly fits to the measured points. A single measurement of 'goodness' of the codec being tested against the reference codec in the form of BD rate is then computed that reflects percentage difference between the codecs. The BD rate percentage difference if positive means that the codec being tested is worse in quality, that is it costs 'x' percentage more bits to generate the same PSNR quality as the reference. The BD rate difference measurement procedure thus allows a straightforward way of computing and independently verifying quality of codec with respect to a reference codec. In terms of specific quality metric for RD calculation, we use both the PSNR metric, as well as the MS-SSIM metric. Thus, we compute two values of BD rates, the first with respect to PSNR, and the second with respect to MS-SSIM; together the two BD rate values offer a fuller picture of quality of a codec as will be shown by our actual measurements.

## Quality Evaluation Test Set, Configurations and Parameters for UHD4K 10-bit

For the purpose of quality evaluation of HEVC Codecs, we define a test set of 6 publicly available challenging UHD4K 10 bit video test sequences at a variety of high frame rates. For the purpose of these tests, video content if not already in YUV 4:2:0 format, is converted to this format for input to MPEG HEVC HM, and MSS HEVC encoders.

The selected UHD4K 10-bit test sequences are shown in Table 11A (and Table 11B). Each sequence is of 4096x2160 resolution, 10-bit bit-depth and 60 fps frame-rate; all sequences of this test set can be obtained from <http://media.xiph.org/video/derf/>. For each selected sequence the first 10 seconds segment (600 frames) length is used for our tests.

Table 11A **Quantizers** used for Qp based Codec RD characteristics measurement on **UHD4K 10 bit** Test Set

UHD4K 10 bit Test Set		Resolution	Bit depth	Frame rate	Num frms	Quantizers used for RD char.			
						Qp1	Qp2	Qp3	Qp4
1	Roller_Coaster	4096x2160	10 bit	60	600	22	23	24	25
2	Driving_POV	4096x2160	10 bit	60	600	26	27	29	31
3	Pier_SeaSide	4096x2160	10 bit	60	600	23	24	25	26
4	Ritual_Dance	4096x2160	10 bit	60	600	24	25	27	29
5	SquareTimeLapse	4096x2160	10 bit	60	600	24	26	28	30
6	BarScene	4096x2160	10 bit	60	600	23	24	25	26

Further for each test sequence two types of tests are performed. The first type of tests are without bitrate control (no BRC) and require specifying quantizer (Qp) values, whereas the second type of tests are with bit rate control (BRC) and require specifying bitrate values.

Since we use MPEG's video quality measurement procedure, i.e., calculation of BD rate measure of an encoder with respect to HM encoder, to calculate the RD curve for the case of *no BRC* we need to specify four quantizer Qp values, while for the case of *BRC* we need to explicitly specify four bitrates per sequence; this is so as four points are needed per sequence to perform curve fitting. In a slight deviation to MPEG procedure, for the case of *no BRC*, instead of using four standard Qp values such as 22, 27, 32, 37 that assumes extreme ranges (of bitrates) of operation and thus larger errors in 4 point curve fitting, we provide, four Qp values per sequence (see Table 11A) that correspond to a moderate range of bitrates of useful applications and where curve fitting is more accurate. Further, to address the case of BRC tests, we provide for each sequence four bit-rate values specified in kbps as shown in Table 11B.

Table 11B **Bitrates** used for BRC based Codec RD characteristics measurement on **UHD4K 10 bit** Test Set

UHD4K 10 bit Test Set		Resolution	Bit depth	Frame rate	Num frms	Bitrate (kbps) used for RD char.			
						BR1	BR2	BR3	BR4
1	Roller_Coaster	4096x2160	10 bit	60	600	20000	16000	12000	9000
2	Driving_POV	4096x2160	10 bit	60	600	20000	16000	12000	9000
3	Pier_SeaSide	4096x2160	10 bit	60	600	20000	16000	12000	9000

\*Other names and brands may be claimed as property of others.

4	Ritual_Dance	4096x2160	10 bit	60	600	20000	16000	12000	9000
5	SquareTimeLapse	4096x2160	10 bit	60	600	20000	16000	12000	9000
6	BarScene	4096x2160	10 bit	60	600	16000	12000	9000	6000

Now that we have introduced the test content, resolution/format, and coding bitrates we are ready to introduce coding configuration, and coding settings used for MPEG HEVC HM, and MSS HEVC Software, and MSS HEVC GAcc Encoders.

HEVC HM encoding is employed in default high quality, high delay Random Access configuration but with only first frame Intra (other Intra's can still happen due to scene changes), pyramid configuration of 8 frames, and 4 Reference Pictures for prediction. For each of encoding tests, the reference quantizer is specified in Table 11A; this quantizer may be internally modulated into individual quantisers needed for I-, P- or B- pictures/slices, including that for reference and nonreference pictures/slices.

The Media Server Studio (MSS) HEVC software encoder is a pure software only encoder that supports a number of Target Usage (TU) settings that range from TU1 to TU7 such as TU1, TU2, TU3, TU4, TU5, TU6, and TU7 offering a gradual range of quality/speed tradeoffs with TU1 being the highest quality/slower speed to TU7 that is the lower quality/fastest speed. In fact, TU1 is referred to as the 'Quality' mode, TU4, as the 'Balanced' mode, and TU7 as the 'Speed' mode. For our quality evaluation tests, in terms of coding configuration and settings, we employ high delay B-pyramid encoding with pyramid length of 8 frames, and up to 4 reference pictures depending on the TU mode such as 4 reference pictures in case of TU1 mode, 3 reference pictures in case of TU4 mode, and 2 reference pictures for the case of TU7 mode. In our performance evaluation tests, we evaluate speed of TU1, TU4, TU5, TU6, and TU7 modes on a number of different PC configurations.

The Media Server Studio (MSS) HEVC GAcc encoder is a hybrid (software with Intel® Graphics accelerated) encoder that supports a number of Target Usage (TU) settings that range from TU4-GAcc to TU7-GAcc such as TU4-GAcc, TU5-GAcc TU6-GAcc, and TU7-GAcc offering a range of quality/speed tradeoffs with TU4-GAcc being the good quality/moderate speed mode to TU7-GAcc that is the lower quality/fastest speed mode. Again, it would be appropriate to call TU4-GAcc, as the 'Balanced' mode, and TU7-GAcc as the 'Speed' mode. For our quality evaluation tests, in terms of configuration and settings, we employ high delay B-pyramid encoding with pyramid length set to 8, and either 3 or 2 reference pictures depending on the TU mode such as 3 reference pictures in case of TU4 mode, and 2 reference pictures for the case of TU7 mode. In our performance evaluation tests, we evaluate speed of TU4-GAcc, TU5-GAcc, TU6-GAcc, and TU7-GAcc modes. In terms of comparison of speed of MSS HEVC Software Encoder's TU4 mode vs MSS HEVC GAcc Encoder's TU4-GAcc mode, the TU4-GAcc mode is expected to be around 30% faster than the TU4 mode; this is also expected to be true for TU5 vs TU5-GAcc, TU6 vs TU6-GAcc, and TU7-TU7-GAcc modes.

As mentioned earlier, for evaluation of quality of MSS HEVC codecs with respect to HM16.18, we will be using the MPEG BD rate metric that performs curve fitting between four points for which measurements are made of a quality metric vs the bitrate. We will be employing two types of quality metrics, PSNR, and MS-SSIM, and thus we will calculate two types of BD-rate, the first wrt PSNR, and the second wrt MS-SSIM.

## Results of Quality Evaluation Tests for UHD4K 10-bit

Before discussing detailed BD rate differences of each MSS HEVC TU mode wrt HM 16.18, we first establish the quality/bitrate measurement of HM 16.18 that will be used as reference.

First, each video sequence of UHD4K 10-bit is encoded using MPEG HEVC HM16.18 Reference Encoder with each of 4 quantizers as specified in Table 11A. As discussed earlier, coding configuration/settings include single intra (first) frame with exception for scene changes, pyramid frame configuration of size 8, and 4 references for prediction. The overall PSNR (averaged over all frames) for each test sequence for each Qp for each of luma (Y), and associated chroma components (U and V) is collected along with the generated coding bitrate. Further, the overall MS-SSIM (averaged over all frames) is also calculated for each test sequence for each Qp for luma (Y) component of frame only (while the chroma MS-SSIM can also be calculated in the same way, MS-SSIM was defined for luma only so it is customarily used in that manner).

For instance, Table 12 shows the results of HM16.18 encoding comprising of average luma PSNR (chroma PSNR is also collected but is not shown to keep tables manageable in size), average MS-SSIM, and total bitrate for each test sequence for each of 4 Qps. For each sequence, for each of four Qps, the first line shows luma PSNR in dB of coded video, whereas the second line shows the corresponding MS-SSIM value (a floating point number in 0-1.0) range. These results are used in curve fitting to generate a continuous RD curve for HM16.18 encoding of that test sequence; the first corresponds to PSNR quality metric, and the second corresponds to MS-SSIM quality metric.

Table 12 **HM16.18** Encoding results for each of 4 Qp's on **UHD4K 10 bit** Test set

UHD4K 10 bit Test Set	Qp1		Qp2		Qp3		Qp4	
	Y PSNR dB /MS-SSIM	Bitrate, kbps	Y PSNR dB /MS-SSIM	Bitrate, kbps	Y PSNR dB /MS-SSIM	Bitrate, kbps	Y PSNR dB /MS-SSIM	Bitrate, kbps
1 RollerCoaster	45.30 0.9948	19116.29	44.97 0.9943	14661.51	44.65 0.9939	11536.79	44.31 0.9933	9301.11
2 Driving_POV	39.88 0.9878	22334.18	39.47 0.9866	18277.12	38.62 0.9835	12801.12	37.70 0.9799	8883.75
3 Pier_SeaSide	43.80 0.9932	19750.66	43.43 0.9924	15285.14	43.03 0.9915	12008.25	42.61 0.9906	9607.96
4 Ritual_Dance	42.96 0.9917	19303.32	42.65 0.9909	16718.97	41.95 0.9889	12828.71	41.15 0.9863	9973.11
5 SquareTimeLapse	42.18 0.9935	21435.88	41.29 0.9916	15418.02	40.33 0.9891	11314.81	39.32 0.9859	8436.22
6 BarScene	39.86 0.9810	22930.26	39.71 0.9802	13688.50	39.60 0.9796	8273.00	39.50 0.9790	5127.71

\*Other names and brands may be claimed as property of others.

Next, the HEVC Software Encoder, and HEVC GAcc Encoder undergo quality evaluation tests. For MSS HEVC Software Encoder, evaluation tests are conducted for five TU mode (TU1, TU4, TU5, TU6, TU7) each of which represents different quality/performance tradeoffs. Each test consists of performing encoding with MSS HEVC Encoder for a particular TU mode, each test sequence, for each of 4 quantizers, and from coded sequence calculating PSNRs of Y, U, and V, MS-SSIM of Y, and corresponding bitrates. This data is collected for all TU modes that need to be tested, and for each TU mode generating a continuous RD curve.

The RD curve for each sequence for each TU is then compared to HM16.18's RD curve and two BD rate percentages, one for each of two objective quality metrics (PSNR, and MS-SSIM) is computed that reflects the difference in quality between a test sequence's MSS TU mode and the HM16.18 reference. For instance a BD rate percentage of say 4% for MSS HEVC Software Encoder TU1 mode means that MSS HEVC Software Encoder TU1 mode in order to provide the same objective quality as HM16.18 would require 4% additional bits. For calculation of BD rate, the standard HEVC provided macro for BD rate is used.

Table 13A shows for CQP based coding the measured BD rate based on PSNR as percentage (for luma, and chroma components), and BD rate based on MS-SSIM as percentage (for luma component) for each of for each test sequence of UHD4K 10-bit test set shown in Table 11A for each of 5 TU modes (TU1, TU4, TU5, TU6, TU7) being evaluated.

Table 13A Quality comparison of **MSS HEVC Software Encoder** at various target usage (**TU**) settings with **MPEG HEVC HM 16.18 Encoder** on **UHD4K 10 bit** test set for constant Qp (**CQP**) based encoding. Two quality comparison metrics **BD rate** based on **PSNR** of luma and chroma, and **BD rate** based on **MS-SSIM** of luma are employed.

UHD4K 10 bit Test Set	TU1 CQP		TU4 CQP		TU5 CQP		TU6 CQP		TU7 CQP	
	% BD Rate based on PSNR/MS-SSIM		% BD Rate based on PSNR/MS-SSIM		% BD Rate based on PSNR/MS-SSIM		% BD Rate based on PSNR/MS-SSIM		% BD Rate based on PSNR/MS-SSIM	
	Y	U/V	Y	U/V	Y	U/V	Y	U/V	Y	U/V
1 RollerCoaster	7.87	2.81/2.68	34.82	33.57/22.36	46.99	65.38/44.42	54.01	71.43/50.61	56.59	76.16/53.87
	8.14	-	33.33	-	47.17	-	53.56	-	55.76	-
2 Driving_POV	2.05	1.17/2.30	17.28	16.72/4.88	20.15	48.21/27.88	29.37	51.41/31.58	31.16	54.78/33.22
	2.92	-	16.99	-	19.54	-	30.36	-	32.31	-
3 Pier_SeaSide	5.81	-2.00/.12	16.42	7.62/2.78	24.09	85.89/35.47	25.45	87.95/38.59	27.09	83.69/38.21
	5.98	-	12.10	-	17.64	-	18.01	-	20.29	-
4 Ritual_Dance	4.91	-2.04/-2.09	18.12	11.82/14.74	22.56	31.06/30.95	28.97	37.29/37.73	32.23	43.66/43.78
	4.78	-	17.12	-	21.69	-	27.82	-	30.75	-
5 SquareTimeLapse	2.49	-11.32/-9.75	18.44	1.39/3.51	23.12	16.92/18.90	30.83	23.97/26.14	32.95	27.19/29.78
	1.95	-	16.94	-	21.48	-	28.16	-	30.11	-
6 BarScene	3.29	18.73/29.51	13.89	12.92/27.47	44.26	65.19/76.79	50.56	78.68/82.71	52.90	77.80/79.70
	5.89	-	14.50	-	61.97	-	65.25	-	68.73	-
<b>Average</b>	<b>4.40</b>	<b>1.23/3.80</b>	<b>19.83</b>	<b>14.01/12.62</b>	<b>30.20</b>	<b>52.11/39.07</b>	<b>36.53</b>	<b>58.46/44.56</b>	<b>38.82</b>	<b>60.55/46.43</b>

As can be observed for UHD4K 10-bit content in CQP based coding from Table 13A, average luma PSNR based BD rate percentage difference of MSS HEVC Software Encoder over HM16.18 (an ideal reference) is 4.4%, 19.8%, 30.2%, 36.5%, and 38.8% higher respectively for TU1, TU4, TU5, TU6, and TU7 modes. This means that for UHD4K 10-bit test set, for MSS HEVC Software Encoder to achieve the same luma PSNR quality as HM16.18 requires in TU1 mode requires close to the same bitrate (4% more) as HM16.18, in TU4 mode 19.8% higher bitrate than HM16.18, in TU5 mode 30.2% higher bitrate than HM16.18, in TU6 mode 36.5% higher bitrate than HM16.18, and in TU7 mode 38.8% higher bitrate than HM16.18. Further for reference, MSS HEVC Software Encoder is 60 to 1200 times faster (depending on TU used, as shown in a later section) as compared to HEVC's HM16.18 Encoder implementation.

Since, MS-SSIM is expected to correlate closely to human visual perception of quality, we now perform a similar assessment of BD rate difference of MSS HEVC Software Encoder in various TU modes over HM16.18 Encoder, but with BD-rate based on MS-SSIM. Again, for UHD4K 10-bit test set, Table 13A shows that the average luma MS-SSIM based BD rate percentage difference of MSS HEVC Software Encoder over HM16.18 (an ideal reference) is 4.9%, 18.5%, 31.6%, 37.2%, and 39.7% higher respectively in TU1, TU4, TU5, TU6, and TU7 modes. This means that for UHD4K 10-bit test set, the MSS HEVC Software Encoder to achieve the same luma MS-SSIM quality as HM16.18 requires in TU1 mode requires very similar (5% more) bitrate as HM16.18, in TU4 mode 18.5% higher bitrate than HM16.18, in TU5 mode 31.6% higher bitrate than HM16.18, in TU6 mode 37.2% higher bitrate than HM16.18 in TU6, and in TU7 mode 39.7% higher bitrate than HM16.18. For UHD4K 10-bit, in terms of comparing BD rate based on PSNR vs BD rate based on MS-SSIM, BD rate value based on MS-SSIM seems to be 0.5 to 1.5% more for each TU's than the BD rate based on PSNR. This is so as subjective visual quality improvement algorithms that we had implemented for HD1080p 8bit coding, have not yet been implemented for for UHD4K 10-bit encoding; thus the BD rate based on MS-SSIM is a little larger than BD rate based on PSNR.

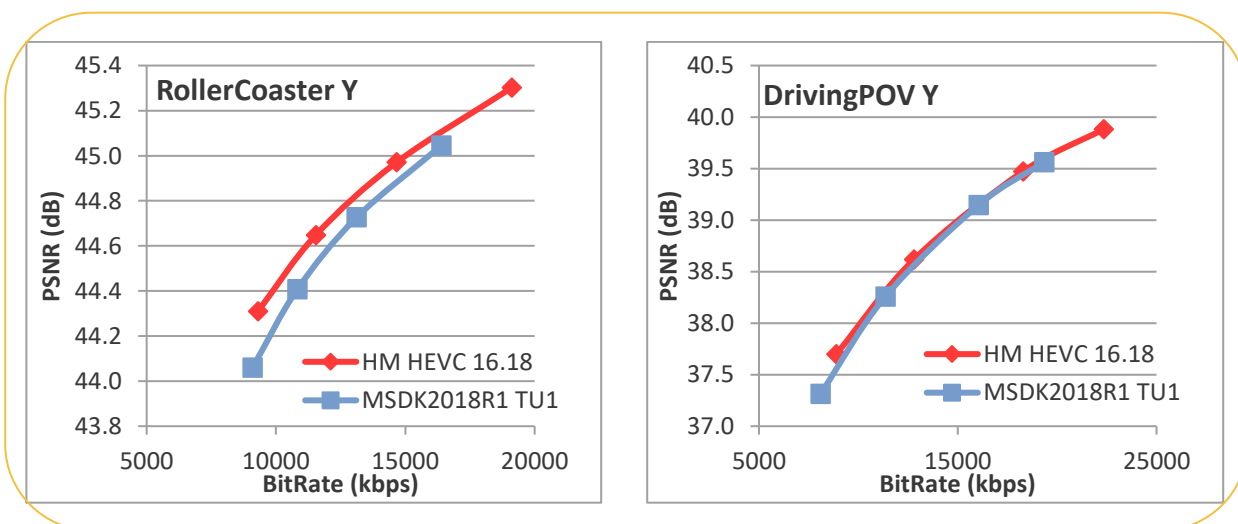

\*Other names and brands may be claimed as property of others.

Figure 11A RD results of UHD4K 10 bit sequences with the biggest and the smallest quality difference (based on BD rate based on PSNR) of MSS HEVC Software Encoder TU1 mode wrt HM16.18, both performing CQp based encoding.

Fig. 11A shows for UHD4K 10-bit test set, luma PSNR based RD characteristics of the MSS HEVC Software Encoder TU1 mode with HM16.18 Encoder for the cases where their difference in quality is the highest (left-hand graph) and the lowest (right-hand graph). As can be seen, the difference between the two curves is very small not only for the lowest difference case, but also for the highest difference case. This along with BD rate data of Table 13A validates that based on PSNR, the quality of the MSS HEVC Software Encoder TU1 mode is very close to that of HEVC HM reference encoder.

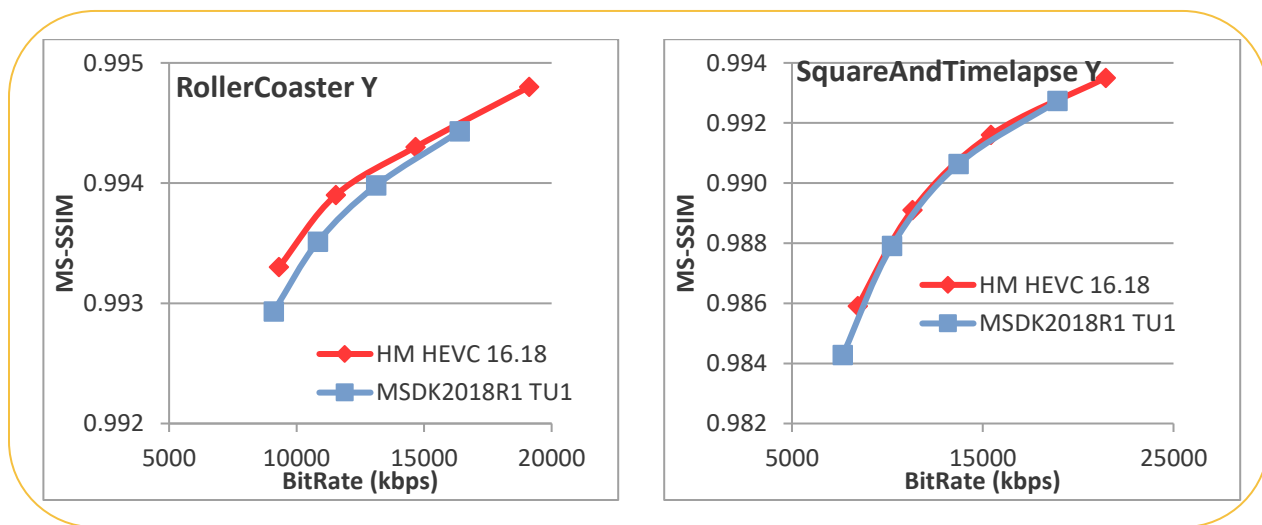

Figure 11B RD results of UHD4K 10 bit sequences with the biggest and the smallest quality difference (based on BD rate based on MS-SSIM) of Media Server Studio's HEVC Software Encoder TU1 mode wrt HM16.18, both performing CQp based encoding.

Similarly, Fig. 11B shows for UHD4K 10-bit test set, luma MS-SSIM based RD characteristics of the HEVC Software Encoder TU1 mode with HM16.18 Encoder for the cases where their difference in quality is the highest (left-hand graph) and the lowest (right-hand graph). As can be seen, the difference between the two curves is small not only for the lowest difference case, but also for the highest difference case. This along with BD rate data of Table 13A validates that also based on MS-SSIM, the quality of the HEVC Software Encoder TU1 mode is very close to that of HEVC HM reference encoder.

Next, for the HEVC GAcc Encoder, evaluation tests are conducted for four TU modes (TU4-GAcc, TU5-GAcc, TU6-GAcc, TU7-GAcc) each of which represents different quality/performance tradeoffs. Each test consists of performing encoding with MSS HEVC Encoder for a particular TU mode, each test sequence, for each of 4 quantizers, and from coded sequence calculating PSNRs of Y, U, and V, MS-SSIM of Y, and corresponding bitrates. This data is collected for all aforementioned TU modes, and for each TU mode a continuous RD

curve is generated. The RD curve for each sequence for each TU-GAcc is then compared to HM16.18's RD curve and two BD rate percentages, one for each of two objective quality metrics (PSNR, and MS-SSIM) is computed that reflects the difference in quality between a MSS HEVC Encoder TU mode and the HM16.18 reference.

Table 13B shows for CQP based coding the measured BD rate based on PSNR as percentage (for luma, and chroma components), and BD rate based on MS-SSIM as percentage (for luma component) for each of for each test sequence of UHD4K 10-bit test set shown in Table 11A for each of 4 TU modes (TU4-GAcc, TU5-GAcc, TU6-GAcc, TU7-GAcc) being evaluated.

Table 13B Quality comparison of **Media Server Studio's HEVC GACC Encoder** at various target usage (TU) settings with **MPEG HEVC HM 16.18 Encoder** on **UHD4K 10 bit** test set for constant Qp (CQP) based encoding. Two quality comparison metrics **BD rate** based on **PSNR** of luma and chroma, and **BD rate** based on **MS-SSIM** of luma are employed.

UHD4K 10 bit Test Set		TU4-GAcc CQP		TU5-GAcc CQP		TU6-GAcc CQP		TU7-GAcc CQP	
		% BD rate based on PSNR/MS-SSIM		% BD rate based on PSNR/MS-SSIM		% BD rate based on PSNR/MS-SSIM		% BD rate based on PSNR/MS-SSIM	
		Y	U/V	Y	U/V	Y	U/V	Y	U/V
1	RollerCoaster	27.50	21.58/11.51	37.77	56.85/35.35	47.53	61.93/40.86	48.62	65.24/42.83
		25.94	-	37.74	-	46.22	-	46.80	-
2	Driving_POV	20.87	18.82/7.18	22.73	53.55/31.96	32.73	53.43/33.14	34.61	56.56/34.59
		21.72	-	23.93	-	35.10	-	37.19	-
3	Pier_SeaSide	16.67	8.79/3.87	23.49	116.31/38.15	24.45	90.96/34.89	26.02	102.34/36.78
		12.61	-	17.56	-	17.04	-	19.43	-
4	Ritual_Dance	16.25	8.27/11.09	19.95	24.26/25.85	26.42	30.09/32.38	29.24	34.70/37.42
		14.94	-	18.86	-	24.84	-	27.37	-
5	SquareTimeLapse	19.65	2.02/3.76	23.92	17.71/19.88	32.27	24.91/26.96	34.43	28.22/30.76
		17.99	-	22.44	-	29.49	-	31.51	-
6	BarScene	18.76	20.61/32.52	50.30	80.73/92.54	58.11	80.16/84.83	58.65	80.41/81.56
		19.02	-	70.24	-	77.56	-	77.80	-
<b>Average</b>		<b>19.95</b>	<b>13.35/11.66</b>	<b>29.69</b>	<b>58.23/40.62</b>	<b>36.92</b>	<b>56.91/42.18</b>	<b>38.60</b>	<b>61.25/43.99</b>
		<b>18.70</b>	<b>-</b>	<b>31.80</b>	<b>-</b>	<b>38.37</b>	<b>-</b>	<b>40.02</b>	<b>-</b>

As can be observed for UHD4K 10-bit content for CQP based coding from Table 13B, average luma PSNR based BD rate percentage difference of MSS HEVC GAcc Encoder over HM16.18 (an ideal reference) is 19.9%, 29.7%, 36.9%, and 38.6% higher respectively for TU4-GAcc, TU5-GAcc, TU6-GAcc, and TU7-GAcc modes. This means that for UHD4K 10-bit test set, for MSS HEVC GAcc Encoder to achieve the same luma PSNR quality as HM16.18 requires in TU4-GAcc mode 19.9% higher bitrate than HM16.18, in TU5-GAcc mode 29.7% higher bitrate than HM16.18, in TU6-GAcc mode 36.9% higher bitrate than HM16.18, and in TU7-GAcc mode 38.6%

\*Other names and brands may be claimed as property of others.



higher bitrate than HM16.18. These quality numbers for MSS HEVC GAcc Encoder compare favorably (within 1%) of the numbers of MSS HEVC Software Encoder. Further for reference, the HEVC GAcc Encoder is 700 to 1,600 times faster (depending on TU used, as shown in a later section) as compared to HEVC's HM16.18 Encoder implementation.

Since, MS-SSIM is expected to correlate closely to human visual perception of quality, we now perform a similar assessment of BD rate difference of MSS HEVC GAcc Encoder in various TU modes over HM16.18, but with BD-rate based on MS-SSIM. Again, for UHD4K 10-bit test set undergoing CQP coding, Table 13B shows that the average luma MS-SSIM based BD rate percentage difference of MSS HEVC Software Encoder over HM16.18 is 18.7%, 31.8%, 38.4%, and 40.0% higher respectively in TU4-GAcc, TU5-GAcc, TU6-GAcc, and TU7-GAcc modes. This means that for UHD4K 10-bit test set, the MSS HEVC Software Encoder to achieve the same luma MS-SSIM quality as HM16.18 requires in TU4-GAcc mode 18.7% higher bitrate than HM16.18, in TU5-GAcc mode 31.8% higher bitrate than HM16.18, in TU6-GAcc mode 38.4% higher bitrate than HM16.18, and in TU7-GAcc mode 40.0% higher bitrate than HM16.18. For UHD4K 10-bit, in terms of comparing BD rate based on PSNR vs BD rate based on MS-SSIM, BD rate value based on MS-SSIM seems to be -1% to 1.5% more for each TU's than the BD rate based on PSNR. This is so as subjective visual quality improvement algorithms that we had implemented for HD1080p 8bit coding, have not yet been implemented for UHD4K 10-bit encoding; thus the BD rate based on MS-SSIM is almost the same or a bit higher than BD rate based on PSNR.

Fig. 11C1 and Fig. 11C2 show for TU4 mode, measured PSNR based RD characteristics of MSS HEVC Software Encoder, and measured PSNR based RD characteristics of MSS HEVC GAcc Encoder with respect to HM 16.18 Encoder respectively.

In Fig. 11C1, the left-hand graph shows PSNR based RD curves of MSS HEVC Software Encoder TU4 mode, and that of the HM 16.18 Encoder for the case when the quality difference between the two is the largest from among the sequences in the test set, and the right-hand graph shows the PSNR based RD curves of MSS HEVC Software Encoder TU4 mode, and that of the HM 16.18 Encoder for the case when the quality difference between the two is the smallest from among the sequences in the test set.

As can be seen from Table 13A, for MSS HEVC Software Encoder TU4 mode or the BD rate (based on PSNR) between the two curves is 34.8% for the case of largest difference and 13.9% for the case of smallest difference. This along with visuals of Fig. 11C1 confirms that based on PSNR, the quality of the MSS HEVC Software Encoder TU4 mode is good as compared to quality of HEVC HM encoder.

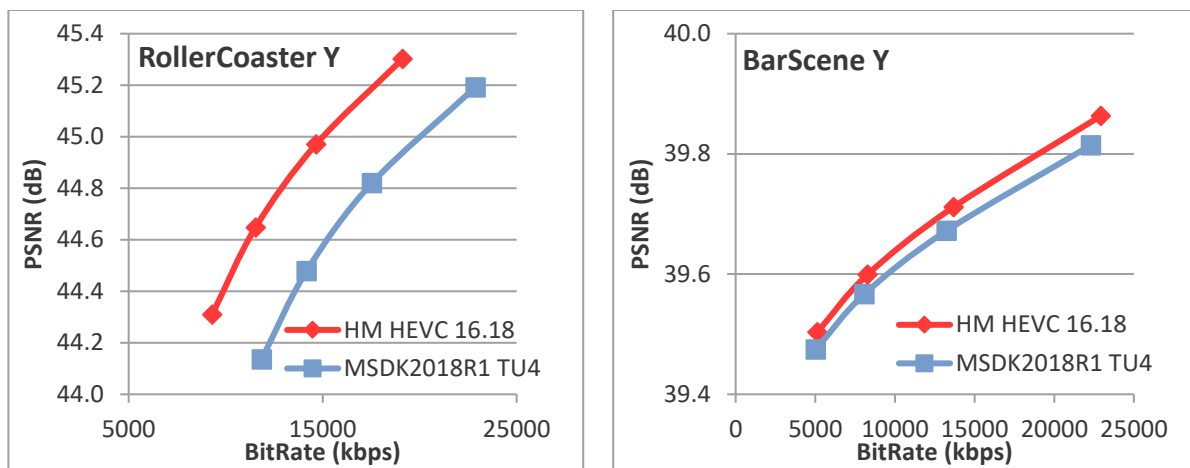
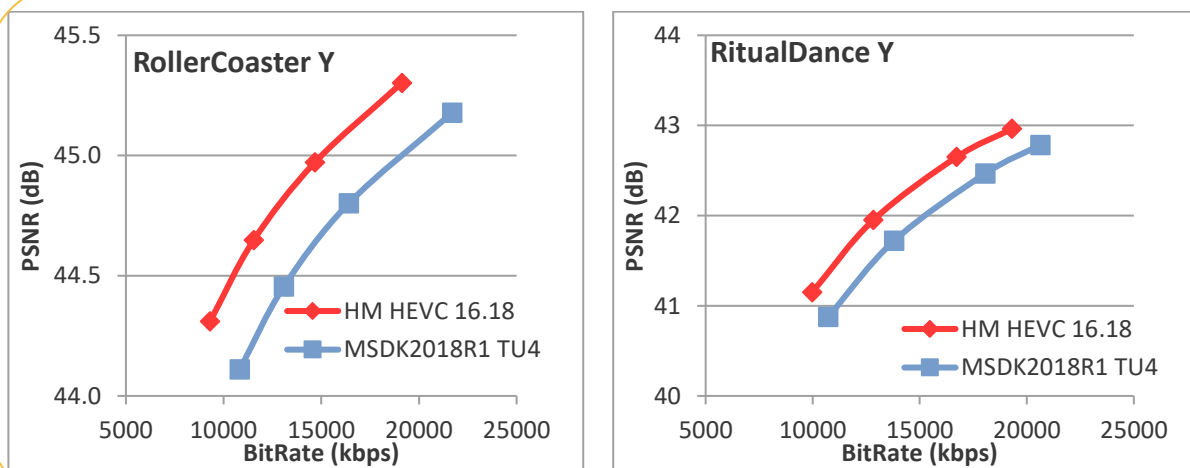

Figure 11C1 RD results of UHD4K 10 bit sequences with the biggest and the smallest quality difference (based on BD rate based on PSNR) of MSS HEVC Software Encoder TU4 mode wrt HM16.18, both performing Cqp based encoding.

Similarly in Fig. 11C2 the left-hand graph shows PSNR based RD curves of the HEVC GAcc Encoder TU4 mode, and that of the HM 16.18 Encoder for the case when the quality difference between the two is the largest from among the sequences in the test set, and the right-hand graph shows the PSNR based RD curves of the HEVC GAcc Encoder TU4 mode, and that of the HM 16.18 Encoder for the case when the quality difference between the two is the smallest from among the sequences in the test set.

As can be seen from Table 13B, for HEVC GAcc Encoder TU4 mode the BD rate (based on PSNR) between the two curves is 27.5% for the case of largest difference and 16.3% for the case of smallest difference. This along with visuals of Fig. 11C2 confirms that based on PSNR, the quality of the HEVC Software Encoder TU4 mode is good as compared to quality of HEVC HM encoder.



\*Other names and brands may be claimed as property of others.

Figure 11C2 RD results of UHD4K 10 bit sequences with the biggest and the smallest quality difference (based on BD rate based on PSNR) of Media Server Studio's HEVC GAcc Encoder TU4 mode wrt HM16.18, both performing CQp based encoding.

Next, Fig. 11D1 and Fig. 11D2 show for TU4 mode, measured MS-SSIM based RD characteristics of the HEVC Software Encoder, and measured MS-SSIM based RD characteristics of HEVC GAcc Encoder with respect to HM 16.18 Encoder respectively.

In Fig. 11D1 the left-hand graph shows MS-SSIM based RD curves of HEVC Software Encoder TU4 mode, and that of the HM 16.18 Encoder for the case when the quality difference between the two is the largest from among the sequences in the test set, and the right-hand graph shows the MS-SSIM based RD curves of MSS HEVC Software Encoder TU4 mode, and that of the HM 16.18 Encoder for the case when the quality difference between the two is the smallest from among the sequences in the test set.

As can be seen from Table 13A, for MSS HEVC Software Encoder TU4 mode or the BD rate (based on MS-SSIM) between the two curves is 33.3% for the case of largest difference and 12.1% for the case of smallest difference. This along with visuals of Fig. 11D1 confirms that based on MS-SSIM, the quality of the HEVC Software Encoder TU4 mode is good as compared to the HEVC HM encoder.

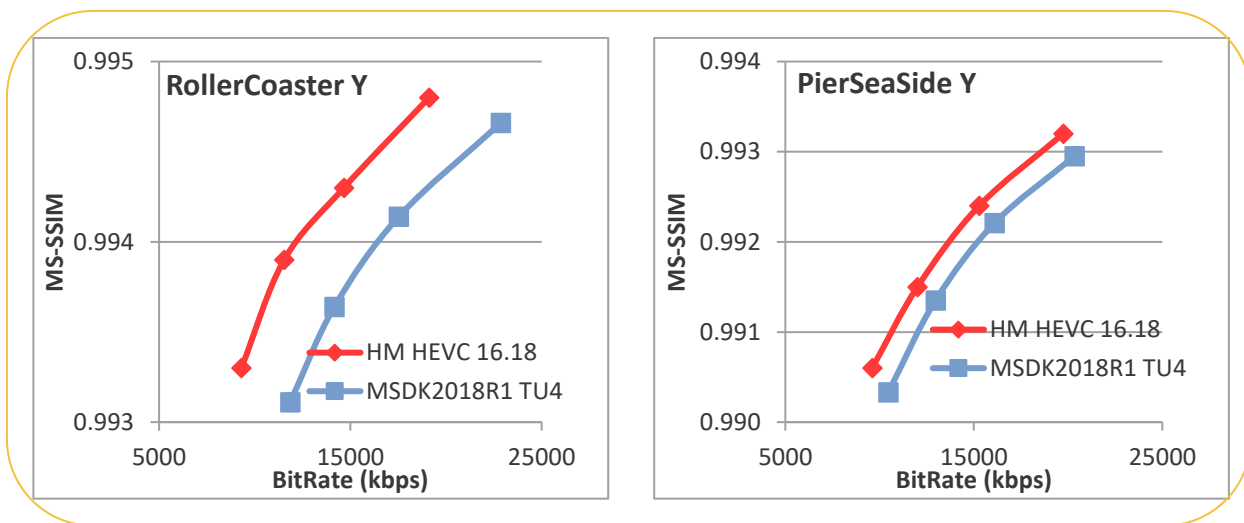

Figure 11D1 RD results of UHD4K 10 bit sequences with the biggest and the smallest quality difference (based on BD rate based on MS-SSIM) of MSS HEVC Software Encoder TU4 mode wrt HM16.18, both performing CQp based encoding.

In Fig. 11D2 the left-hand graph shows MS-SSIM based RD curves of MSS HEVC GAcc Encoder TU4 mode, and that of the HM 16.18 Encoder for the case when the quality difference between the two is the largest from among the sequences in the test set, and the right-hand graph shows the MS-SSIM based RD curves of MSS HEVC Software Encoder TU4 mode, and that of the HM 16.18 Encoder for the case when the quality difference between the two is the smallest from among the sequences in the test set.

As can be seen from Table 13B, for HEVC GAcc Encoder TU4 mode or the BD rate (based on MS-SSIM) between the two curves is 25.9% for the case of largest difference and 12.6% for the case of smallest difference. This along with visuals of Fig. 11D2 confirms that based on MS-SSIM, the quality of the HEVC GAcc Encoder TU4 mode is good as compared to the HEVC HM encoder.

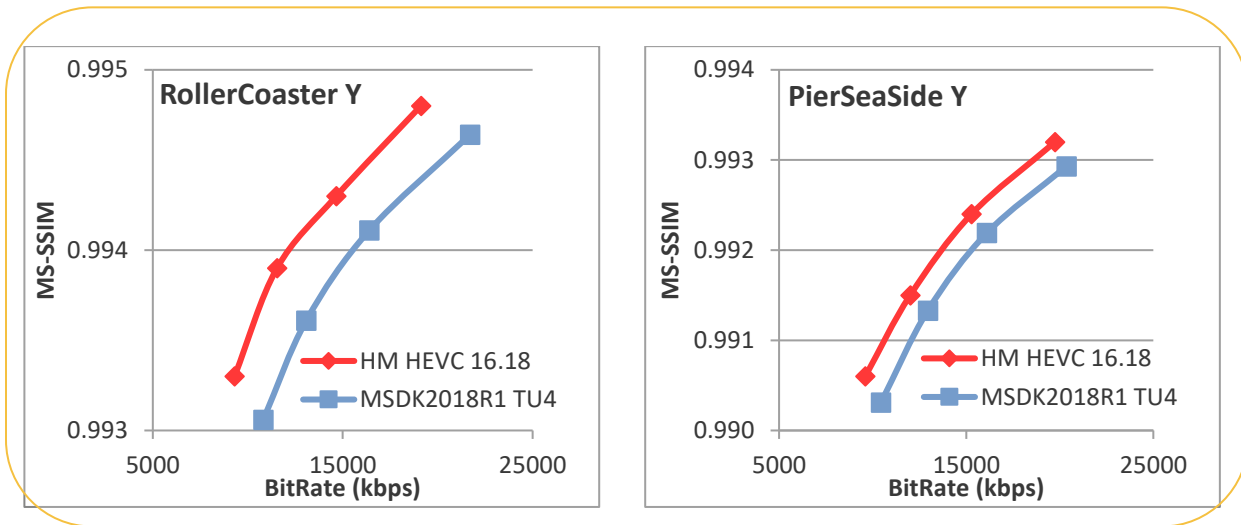

Figure 11D2 RD results of UHD4K 10 bit sequences with the biggest and the smallest quality difference (based on BD rate based on MS-SSIM) of HEVC GAcc Encoder TU4 mode wrt HM16.18, both performing CQp based encoding.

Next, Fig. 11E1 and Fig. 11E2 show for TU7 mode, measured PSNR based RD characteristics of MSS HEVC Software Encoder, and measured PSNR based RD characteristics of MSS HEVC GAcc Encoder with respect to HM 16.18 Encoder respectively.

In Fig. 11E1, the left-hand graph shows PSNR based RD curves of MSS HEVC Software Encoder TU7 mode, and that of the HM 16.18 Encoder for the case when the quality difference between the two is the largest from among the sequences in the test set, and the right-hand graph shows the PSNR based RD curves of HEVC Software Encoder TU7 mode, and that of the HM 16.18 Encoder for the case when the quality difference between the two is the smallest from among the sequences in the test set.

As can be seen from Table 13A, for MSS HEVC Software Encoder TU7 mode or the BD rate (based on PSNR) between the two curves is 56.6% for the case of largest difference and 27.1% for the case of smallest difference. This along with visuals of Fig. 11E1 confirms that based on PSNR, the quality of the HEVC Software Encoder TU7 mode is fair as compared to the HEVC HM encoder.

\*Other names and brands may be claimed as property of others.

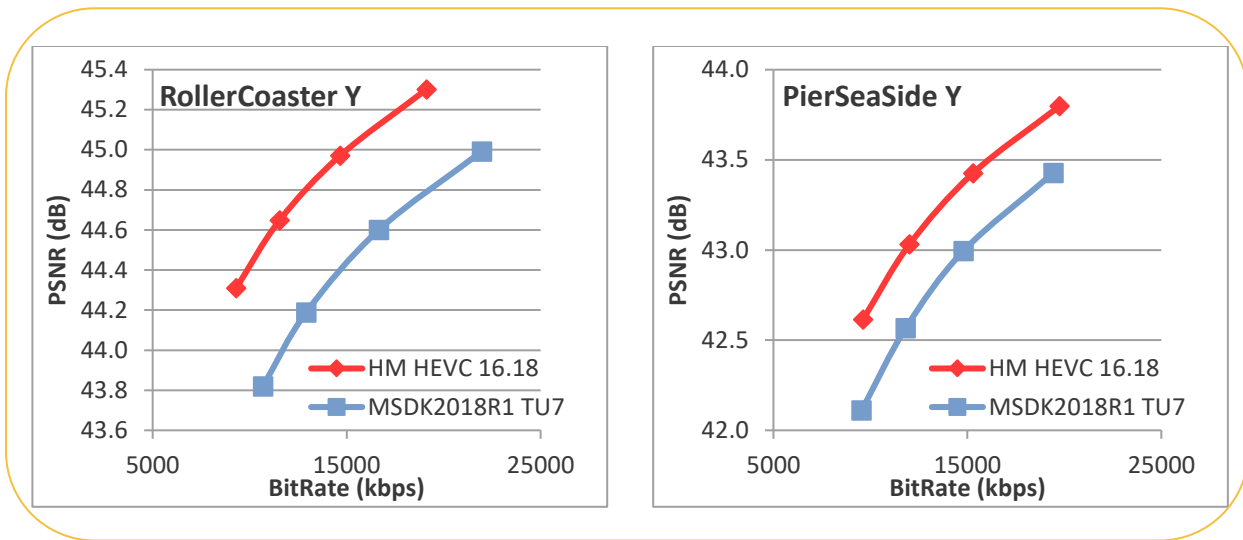

Figure 11E1 RD results of UHD4K 10 bit sequences with the biggest and the smallest quality difference (based on BD rate based on PSNR) of HEVC Software Encoder TU7 mode wrt HM16.18, both performing CQp based encoding.

In Fig. 11E2, the left-hand graph shows PSNR based RD curves of HEVC GAcc Encoder TU7 mode, and that of the HM 16.18 Encoder for the case when the quality difference between the two is the largest from among the sequences in the test set, and the right-hand graph shows the PSNR based RD curves of HEVC GAcc Encoder TU7 mode, and that of the HM 16.18 Encoder for the case when the quality difference between the two is the smallest from among the sequences in the test set.

As can be seen from Table 13B, for HEVC GAcc TU7 mode or the BD rate (based on PSNR) between the two curves is 58.7% for the case of largest difference and 26.0% for the case of smallest difference. This along with visuals of Fig. 11E2 confirms that based on PSNR, the quality of the HEVC GAcc Encoder TU7 mode is fair as compared to the HEVC HM encoder.

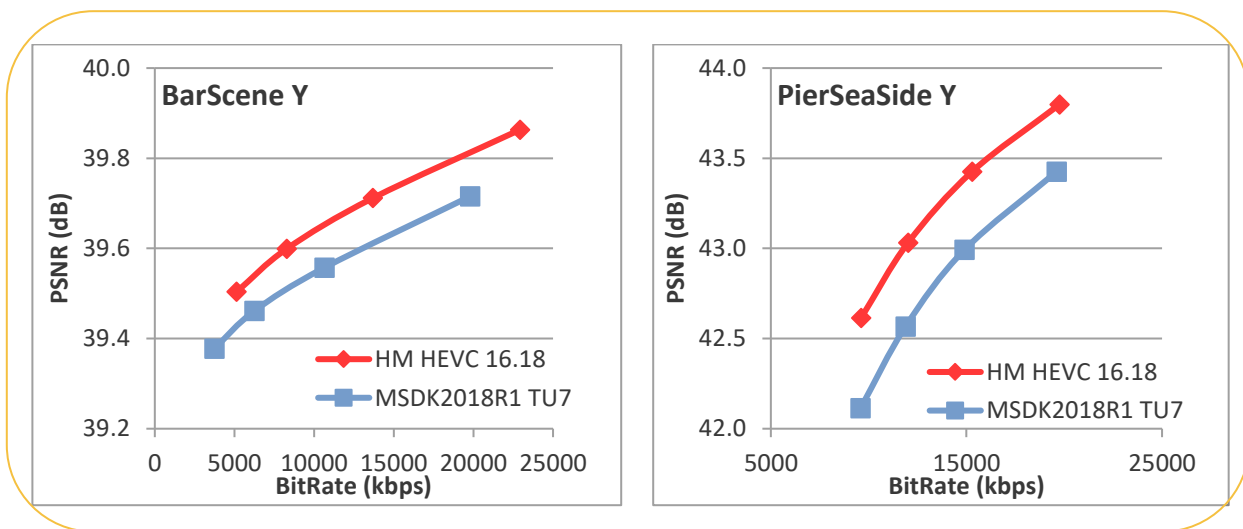

Figure 11E2 RD results of UHD4K 10 bit sequences with the biggest and the smallest quality difference (based on BD rate based on PSNR) of HEVC GAcc Encoder TU7 mode wrt HM16.18, both performing CQp based encoding.

Next, Fig. 11F1 and Fig. 11F2 show for TU7 mode, measured SSIM based RD characteristics of HEVC Software Encoder, and measured MS-SSIM based RD characteristics of MSS HEVC GAcc Encoder with respect to HM 16.18 Encoder respectively.

In Fig. 11F1, the left-hand graph shows MS-SSIM based RD curves of HEVC Software Encoder TU7 mode, and that of the HM 16.18 Encoder for the case when the quality difference between the two is the largest from among the sequences in the test set, and the right-hand graph shows the MS-SSIM based RD curves of HEVC Software Encoder TU7 mode, and that of the HM 16.18 Encoder for the case when the quality difference between the two is the smallest from among the sequences in the test set.

As can be seen from Table 13A, for HEVC Software Encoder TU7 mode or the BD rate (based on MS-SSIM) between the two curves is 68.7% for the case of largest difference and 20.3% for the case of smallest difference. This along with visuals of Fig. 11F1 confirms that based on MS-SSIM, the quality of the HEVC Software Encoder TU7 mode is fair as compared to the HEVC HM encoder.

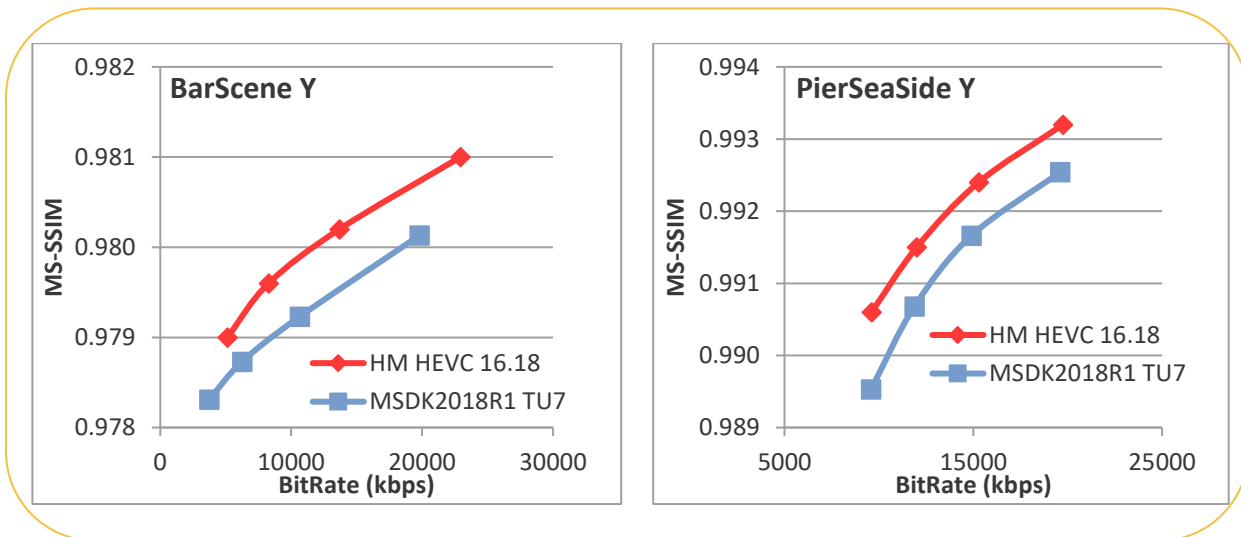

Figure 11F1 RD results of UHD4K 10 bit sequences with the biggest and the smallest quality difference (based on BD rate based on MS-SSIM) of Media Server Studio’s HEVC Software Encoder TU7 mode wrt HM16.18, both performing CQp based encoding.

In Fig. 11F2, the left-hand graph shows MS-SSIM based RD curves of MSS HEVC GAcc Encoder TU7 mode, and that of the HM 16.18 Encoder for the case when the quality difference between the two is the largest from among the sequences in the test set, and the right-hand graph shows the MS-SSIM based RD curves of HEVC GAcc Encoder TU7 mode, and that of the HM 16.18 Encoder for the case when the quality difference between the two is the smallest from among the sequences in the test set.

\*Other names and brands may be claimed as property of others.

As can be seen from Table 13B, for MSS HEVC GAcc Encoder TU7 mode or the BD rate (based on MS-SSIM) between the two curves is 77.8% for the case of largest difference and 19.4% for the case of smallest difference. This along with visuals of Fig. 11F2 confirms that based on MS-SSIM, the quality of the HEVC GAcc Encoder TU7 mode is fair as compared to the HEVC HM encoder.

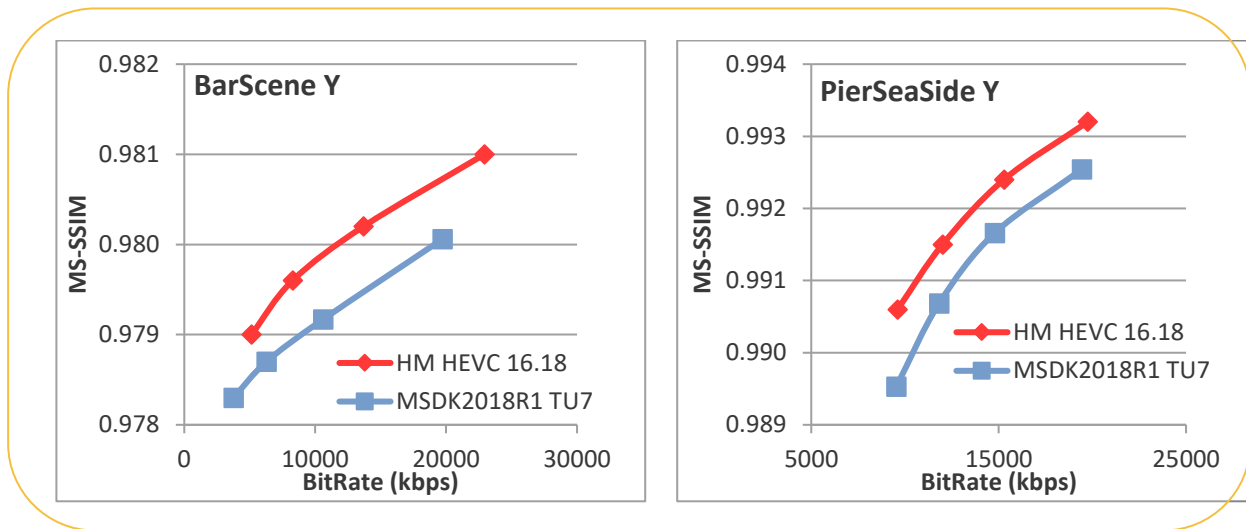

Figure 11F2 RD results of UHD4K 10 bit sequences with the biggest and the smallest quality difference (based on BD rate based on MS-SSIM) of Media Server Studio’s HEVC GAcc Encoder TU7 mode wrt HM16.18, both performing CQp based encoding.

To summarize, for the case of constant Qp (CQp), luma BD rate percentage bitrate difference (based on PSNR or MS-SSIM) of MSS HEVC in various modes with respect to HM16.18 reference encoder is as follows.

- TU1 mode based on PSNR is on average only 4.5% lower in quality (while on average over 60 times faster, as shown later) as compared to HM16.18, an ideal reference. This is highest quality mode for UHD4K 10-bit encoding in MSS HEVC Software Encoder.
- TU4 mode based on PSNR on average is 19.8% lower in quality (while on average over 375 times faster) as compared to HM16.18. This mode represents excellent tradeoff of quality vs speed.
- TU4-GAcc mode based on PSNR on average has the same quality as TU4 mode quality (while on average around 1.6x faster than TU4 at 700 times faster) as compared to HM16.18.
- TU7 mode based on PSNR on average is 38.8% lower in quality (while on average around 1125 times faster) as compared to HM16.18. This is the fastest software only mode for UHD4K 10-bit encoding in MSS HEVC Software Encoder.
- TU7-GAcc mode on average has the same quality as TU7 mode (while on average around 1.4x faster times than TU7 at 1600 times faster) as compared to HM16.18. This is the fastest mode for UHD4K 10-bit encoding in MSS HEVC Software or GAcc Encoders.

Up to now we have discussed constant Qp based encoding where using four quantizer values per sequence we were able to generate RD characteristics curve for Media Server Studio’s HEVC Software and HEVC GAcc

Encoders. Further we also calculated similar RD curve for HM 16.18 Encoder, and compared BD rate (based on PSNR, and based on MS-SSIM) between corresponding RD curves per sequence of MSS HEVC Software and MSS HEVC GAcc Encoders with respect to HM 16.18 Encoder.

Now we present results of BRC tests consisting of CBR mode test results, VBR mode test results, and AVBR mode test results.

Table 14A shows for CBR based coding the measured BD rate based on PSNR as percentage (for luma, and chroma components), and BD rate based on MS-SSIM as percentage (for luma component) difference of MSS HEVC Software Encoder over HM16.18 for each test sequence of UHD4K 10-bit test set shown in Table 11A for each of 5 TU modes (TU1, TU4, TU5, TU6, TU7) being evaluated.

Table 14A Quality comparison of **Media Server Studio's HEVC Software Encoder** at various target usage (TU) settings with **MPEG HEVC HM 16.18 Encoder** on **UHD4K 10 bit** test set for constant bitrate (CBR) based encoding. Two quality comparison metrics **BD rate** based on **PSNR** of luma and chroma, and **BD rate** based on **MS-SSIM** of luma are employed.

UHD4K 10 bit Test Set	TU1 CBR		TU4 CBR		TU5 CBR		TU6 CBR		TU7 CBR	
	% BD Rate based on PSNR/MS-SSIM		% BD Rate based on PSNR/MS-SSIM		% BD Rate based on PSNR/MS-SSIM		% BD Rate based on PSNR/MS-SSIM		% BD Rate based on PSNR/MS-SSIM	
	Y	U/V	Y	U/V	Y	U/V	Y	U/V	Y	U/V
	1 RollerCoaster	10.45 13.69	4.69/1.54 -	39.67 43.73	37.43/22.09 -	50.91 57.55	69.17/44.49 -	58.61 65.42	78.23/52.49 -	61.96 68.74
2 Driving_POV	2.03 3.25	-2.27/-2.24 -	17.05 17.71	17.13/2.77 -	20.16 20.36	43.62/23.57 -	30.87 33.55	46.48/27.12 -	32.46 35.29	49.86/29.00 -
3 Pier_SeaSide	12.22 47.68	-16.71/-23.63 -	20.56 53.48	-9.38/-21.18 -	27.43 62.59	69.39/5.55 -	29.37 60.62	69.03/7.08 -	30.42 63.96	70.27/7.56 -
4 Ritual_Dance	5.04 4.57	-4.71/-4.52 -	18.93 17.65	9.98/12.50 -	23.47 22.04	29.78/28.80 -	30.18 28.24	35.16/34.90 -	33.10 30.67	41.53/41.18 -
5 SquareTimeLaps	7.02 7.85	-11.21/-9.49 -	23.84 24.13	.27/2.80 -	27.82 27.96	13.82/16.48 -	36.52 35.98	20.31/23.39 -	38.68 37.87	23.43/27.06 -
6 BarScene	6.09 12.62	17.67/28.5 -	18.38 22.79	16.72/37.2 -	52.63 75.58	64.50/85.46 -	60.57 81.10	75.87/92.69 -	61.81 82.70	73.92/88.20 -
<b>Average</b>	<b>7.14</b> <b>14.94</b>	<b>-2.09/-1.63</b> <b>-</b>	<b>23.07</b> <b>29.91</b>	<b>12.02/9.37</b> <b>-</b>	<b>27.39</b> <b>36.15</b>	<b>40.69/28.15</b> <b>-</b>	<b>41.02</b> <b>50.82</b>	<b>54.18/39.61</b> <b>-</b>	<b>43.07</b> <b>53.21</b>	<b>57.22/41.58</b> <b>-</b>

As can be observed for UHD4K 10-bit content in CBR based coding from Table 14A, average luma PSNR based BD rate percentage difference of MSS HEVC Software Encoder over HM16.18 is 7.1%, 23.1%, 27.4%, 41.0%, and 43.1% higher respectively for TU1, TU4, TU5, TU6, and TU7 modes. This means that for UHD4K 10-bit test set, for MSS HEVC Software Encoder in CBR based coding to achieve the same luma PSNR quality

\*Other names and brands may be claimed as property of others.



as HM16.18 requires in TU1 mode 7.1% more bitrate as HM16.18, in TU4 mode 23.1% higher bitrate than HM16.18, in TU5 mode 27.4% higher bitrate than HM16.18, in TU6 mode 41.0% higher bitrate than HM16.18, and in TU7 mode 43.1% higher bitrate than HM16.18.

Further for UHD4K 10-bit test set in CBR based coding from Table 14A also shows that the average luma MS-SSIM based BD rate percentage difference of MSS HEVC Software Encoder over HM16.18 is 14.9%, 29.9%, 36.2%, 50.8%, and 53.2% higher respectively in TU1, TU4, TU5, TU6, and TU7 modes. This means that for UHD4K 10-bit test set, the MSS HEVC Software Encoder to achieve the same luma PSNR quality as HM16.18 requires in TU1 mode nearly 14.9% more bitrate than HM16.18, in TU4 mode 29.9% higher bitrate than HM16.18, in TU5 mode 36.2% higher bitrate than HM16.18, in TU6 mode 50.8% higher bitrate than HM16.18 in TU6, and in TU7 mode 53.2% higher bitrate than HM16.18. For UHD4K 10-bit, in terms of comparing BD rate based on PSNR vs BD rate based on MS-SSIM, BD rate value based on MS-SSIM seems to be around 7-10% more for each TU's than the BD rate based on PSNR; as noted for CQP case, this is due to the fact that the visual quality improvement algorithms have yet to be extended and integrated for UHD4K 10-bit.

Table 14B shows for CBR based coding the measured BD rate based on PSNR as percentage (for luma, and chroma components), and BD rate based on MS-SSIM as percentage (for luma component) difference of MSS HEVC GAcc Encoder over HM16.18 for each test sequence of UHD4K 10-bit test set shown in Table 11A for each of 4 TU modes (TU4-GAcc, TU5-GAcc, TU6-GAcc, TU7-GAcc) being evaluated.

Table 14B Quality comparison of **Media Server Studio's HEVC GACC Encoder** at various target usage (TU) settings with **MPEG HEVC HM 16.18 Encoder** on **UHD4K 10 bit** test set for constant bitrate (CBR) based encoding. Two quality comparison metrics **BD rate** based on **PSNR** of luma and chroma, and **BD rate** based on **MS-SSIM** of luma are employed.

UHD4K 10 bit Test Set	TU4-GAcc CBR		TU5-GAcc CBR		TU6-GAcc CBR		TU7-GAcc CBR	
	% BD rate based on PSNR/MS-SSIM		% BD rate based on PSNR/MS-SSIM		% BD rate based on PSNR/MS-SSIM		% BD rate based on PSNR/MS-SSIM	
	Y	U/V	Y	U/V	Y	U/V	Y	U/V
1 RollerCoaster	30.40	22.03/8.00	39.83	56.43/31.84	50.67	63.93/37.76	51.73	67.54/39.75
	33.45	-	44.98	-	55.13	-	56.33	-
2 Driving_POV	20.57	19.48/5.37	22.44	48.67/28.41	33.27	49.66/30.12	35.20	52.99/31.55
	22.42	-	24.57	-	37.17	-	39.47	-
3 Pier_SeaSide	20.05	-7.87/-19.50	24.82	85.94/7.86	26.73	73.64/4.66	27.88	84.31/4.73
	49.45	-	57.10	-	57.24	-	59.23	-
4 Ritual_Dance	17.34	6.76/9.17	20.87	22.19/23.66	27.65	27.89/29.64	30.37	32.35/34.85
	15.45	-	18.97	-	25.07	-	27.43	-
5 SquareTimeLapse	25.32	1.12/3.62	28.88	15.02/17.85	37.77	21.64/24.54	40.16	25.35/28.88
	25.71	-	29.17	-	37.05	-	39.31	-
6 BarScene	24.59	24.07/42.7	55.64	77.11/99.25	65.80	76.99/93.37	65.52	73.17/88.13
	29.31	-	79.95	-	91.24	-	88.73	-

<b>Average</b>	<b>23.04</b>	<b>10.93/8.23</b>	<b>32.08</b>	<b>50.89/34.81</b>	<b>40.32</b>	<b>52.29/36.68</b>	<b>41.81</b>	<b>55.95/37.98</b>
	<b>29.30</b>	<b>-</b>	<b>42.46</b>	<b>-</b>	<b>50.48</b>	<b>-</b>	<b>51.75</b>	<b>-</b>

As can be observed for UHD4K 10-bit content for CBR based coding from Table 14B, average luma PSNR based BD rate percentage difference of MSS HEVC GAcc Encoder over HM16.18 is 23.0%, 32.1%, 40.3%, and 41.8% higher respectively for TU4-GAcc, TU5-GAcc, TU6-GAcc, and TU7-GAcc modes. This means that for UHD4K 10-bit test set, for MSS HEVC GAcc Encoder in CBR based coding to achieve the same luma PSNR quality as HM16.18 requires in TU4-GAcc mode 23.0% higher bitrate than HM16.18, in TU5-GAcc mode 32.1% higher bitrate than HM16.18, in TU6-GAcc mode 40.3% higher bitrate than HM16.18, and in TU7-GAcc mode 41.8% higher bitrate than HM16.18. These PSNR based quality numbers for MSS HEVC GAcc Encoder are very similar to the numbers of MSS HEVC Software Encoder.

Again, for UHD4K 10-bit test set undergoing CBR coding, Table 14B also shows that the average luma MS-SSIM based BD rate percentage difference of MSS HEVC GAcc Encoder over HM16.18 is 29.3%, 42.5%, 50.5%, and 51.8% higher respectively in TU4-GAcc, TU5-GAcc, TU6-GAcc, and TU7-GAcc modes. This means that for UHD4K 10-bit test set, the MSS HEVC GAcc Encoder to achieve the same luma MS-SSIM quality as HM16.18 requires in TU4-GAcc mode 29.3% higher bitrate than HM16.18, in TU5-GAcc mode 42.5% higher bitrate than HM16.18, in TU6-GAcc mode 50.5% higher bitrate than HM16.18, and in TU7-GAcc mode 51.8% higher bitrate than HM16.18. For UHD4K 10-bit, in terms of comparing BD rate based on PSNR vs BD rate based on MS-SSIM, BD rate value based on MS-SSIM seems to be around 6-10% more for each TU's than the BD rate based on PSNR; as noted for CQp case, this is due to the fact that the visual quality improvement algorithms have yet to be extended and integrated for UHD4K 10-bit.

Table 15A shows for VBR based coding the measured BD rate based on PSNR as percentage (for luma, and chroma components), and BD rate based on MS-SSIM as percentage (for luma component) difference of MSS HEVC Software Encoder over HM16.18 for each test sequence of UHD4K 10-bit test set shown in Table 11A for each of 5 TU modes (TU1, TU4, TU5, TU6, TU7) being evaluated.

Table 15A Quality comparison of **Media Server Studio HEVC Software Encoder** at various target usage (**TU**) settings with **MPEG HEVC HM 16.18 Encoder** on **UHD4K 10 bit** test set for variable bitrate (**VBR**) based encoding. Two quality comparison metrics **BD rate** based on **PSNR** of luma and chroma, and **BD rate** based on **MS-SSIM** of luma are employed.

UHD4K 10 bit Test Set	TU1 VBR		TU4 VBR		TU5 VBR		TU6 VBR		TU7 VBR	
	% BD Rate based on PSNR/MS-SSIM		% BD Rate based on PSNR/MS-SSIM		% BD Rate based on PSNR/MS-SSIM		% BD Rate based on PSNR/MS-SSIM		% BD Rate based on PSNR/MS-SSIM	
	Y	U/V	Y	U/V	Y	U/V	Y	U/V	Y	U/V
1 RollerCoaster	10.45	4.69/1.54	39.67	37.43/22.09	50.91	69.17/44.49	58.61	78.23/52.49	61.96	84.33/56.50
	13.69	-	43.73	-	57.55	-	65.42	-	68.74	-
2 Driving_POV	2.03	-2.27/-2.24	17.05	17.13/2.77	20.16	43.62/23.57	30.87	46.48/27.12	32.46	49.86/29.00
	3.25	-	17.71	-	20.36	-	33.55	-	35.29	-

\*Other names and brands may be claimed as property of others.

3	Pier_SeaSide	12.22	-16.71/-23.63	20.56	-9.38/-21.18	27.43	69.39/5.55	29.37	69.03/7.08	30.42	70.27/7.56
		47.68	-	53.48	-	62.59	-	60.62	-	63.96	-
4	Ritual_Dance	5.04	-4.71/-4.52	18.93	9.98/12.50	23.47	29.78/28.80	30.18	35.16/34.90	33.10	41.53/41.18
		4.57	-	17.65	-	22.04	-	28.24	-	30.67	-
5	SquareTimeLaps	5.47	-11.22/-9.42	22.06	-.28/2.28	26.62	14.74/17.51	34.60	20.51/23.70	36.42	23.09/26.73
		5.77	-	21.63	-	26.04	-	33.23	-	34.84	-
6	BarScene	6.09	17.67/28.5	18.38	16.72/37.26	52.63	64.50/85.46	60.57	75.87/92.6	61.81	73.92/88.20
		12.62	-	22.79	-	75.58	-	81.10	-	82.70	-
<b>Average</b>		<b>6.88</b>	<b>-2.09/-1.62</b>	<b>22.77</b>	<b>11.93/9.29</b>	<b>33.54</b>	<b>48.53/34.23</b>	<b>40.70</b>	<b>54.21/39.66</b>	<b>42.70</b>	<b>57.17/41.53</b>
		<b>14.60</b>	<b>-</b>	<b>29.50</b>	<b>-</b>	<b>44.03</b>	<b>-</b>	<b>50.36</b>	<b>-</b>	<b>52.70</b>	<b>-</b>

As can be observed for UHD4K 10-bit content in VBR based coding from Table 15A, average luma PSNR based BD rate percentage difference of Media Server Studio HEVC Software Encoder over HM16.18 is 6.9%, 22.8%, 33.5%, 40.7%, and 42.7% higher respectively for TU1, TU4, TU5, TU6, and TU7 modes. This means that for UHD4K 10-bit test set, for MSS HEVC Software Encoder in VBR based coding to achieve the same luma PSNR quality as HM16.18 requires in TU1 mode 6.9% more bitrate as HM16.18, in TU4 mode 22.8% higher bitrate than HM16.18, in TU5 mode 33.5% higher bitrate than HM16.18, in TU6 mode 40.7% higher bitrate than HM16.18, and in TU7 mode 42.7% higher bitrate than HM16.18.

Further for UHD4K 10-bit test set in VBR based coding from Table 15A also shows that the average luma MS-SSIM based BD rate percentage difference of HEVC Software Encoder over HM16.18 is 14.6%, 29.5%, 44.0%, 50.4%, and 52.7% higher respectively in TU1, TU4, TU5, TU6, and TU7 modes. This means that for UHD4K 10-bit test set, the HEVC Software Encoder to achieve the same luma PSNR quality as HM16.18 requires in TU1 mode nearly 14.6% more bitrate than HM16.18, in TU4 mode 29.5% higher bitrate than HM16.18, in TU5 mode 44.0% higher bitrate than HM16.18, in TU6 mode 50.4% higher bitrate than HM16.18 in TU6, and in TU7 mode 52.7% higher bitrate than HM16.18. For UHD4K 10-bit, in terms of comparing BD rate based on PSNR vs BD rate based on MS-SSIM, BD rate value based on MS-SSIM seems to be around 8-10% more for each TU's than the BD rate based on PSNR; as noted for CQP case, this is due to the fact that the visual quality improvement algorithms have yet to be extended and integrated for UHD4K 10-bit.

Table 15B shows for VBR based coding the measured BD rate based on PSNR as percentage (for luma, and chroma components), and BD rate based on MS-SSIM as percentage (for luma component) difference of MSS HEVC GAcc Encoder over HM16.18 for each test sequence of UHD4K 10-bit test set shown in Table 11A for each of 4 TU modes (TU4-GAcc, TU5-GAcc, TU6-GAcc, TU7-GAcc) being evaluated.

Table 15B Quality comparison of **Media Server Studio HEVC GACC Encoder** at various target usage (TU) settings with **MPEG HEVC HM 16.18 Encoder** on **UHD4K 10 bit** test set for variable bitrate (VBR) based encoding. Two quality comparison metrics **BD rate** based on **PSNR** of luma and chroma, and **BD rate** based on **MS-SSIM** of luma are employed.

UHD4K 10 bit Test Set	TU4-GAcc VBR		TU5-GAcc VBR		TU6-GAcc VBR		TU7-GAcc VBR	
	% BD rate based on PSNR/MS-SSIM		% BD rate based on PSNR/MS-SSIM		% BD rate based on PSNR/MS-SSIM		% BD rate based on PSNR/MS-SSIM	
	Y	U/V	Y	U/V	Y	U/V	Y	U/V
1 RollerCoaster	30.40	22.03/8.00	39.83	56.43/31.84	50.67	63.93/37.76	51.73	67.54/39.75
	33.45	-	44.98	-	55.13	-	56.33	-
2 Driving_POV	20.57	19.48/5.37	22.44	48.67/28.41	33.27	49.66/30.12	35.20	52.99/31.55
	22.42	-	24.57	-	37.17	-	39.47	-
3 Pier_SeaSide	20.05	-7.87/-19.50	24.82	85.94/7.86	26.73	73.64/4.66	27.88	84.31/4.73
	49.45	-	57.10	-	57.24	-	59.23	-
4 Ritual_Dance	17.34	6.76/9.17	20.87	22.19/23.66	27.65	27.89/29.63	30.37	32.35/34.86
	15.45	-	18.97	-	25.07	-	27.41	-
5 SquareTimeLapse	23.23	.52/3.09	27.39	15.95/18.76	35.89	21.62/24.68	37.85	25.11/28.52
	22.77	-	26.87	-	34.47	-	36.32	-
6 BarScene	24.59	24.07/42.75	55.64	77.11/99.25	65.80	76.99/93.37	65.52	73.17/88.13
	29.31	-	79.95	-	91.24	-	88.73	-
Average	22.69	10.83/8.15	31.83	51.05/34.96	40.00	52.29/36.70	41.43	55.91/37.92
	28.81	-	42.07	-	50.05	-	51.25	-

As can be observed for UHD4K 10-bit content for VBR based coding from Table 15B, average luma PSNR based BD rate percentage difference of MSS HEVC GAcc Encoder over HM16.18 is 22.7%, 31.8%, 40.0%, and 41.4% higher respectively for TU4-GAcc, TU5-GAcc, TU6-GAcc, and TU7-GAcc modes. This means that for UHD4K 10-bit test set, for MSS HEVC GAcc Encoder in VBR based coding to achieve the same luma PSNR quality as HM16.18 requires in TU4-GAcc mode 22.7% higher bitrate than HM16.18, in TU5-GAcc mode 31.8% higher bitrate than HM16.18, in TU6-GAcc mode 40.0% higher bitrate than HM16.18, and in TU7-GAcc mode 41.4% higher bitrate than HM16.18. These PSNR based quality numbers for MSS HEVC GAcc Encoder are almost the same as the numbers of MSS HEVC Software Encoder.

Again, for UHD4K 10-bit test set undergoing VBR coding, Table 15B also shows that the average luma MS-SSIM based BD rate percentage difference of MSS HEVC GAcc Encoder over HM16.18 is 28.8%, 42.1%, 50.1%, and 51.3% higher respectively in TU4-GAcc, TU5-GAcc, TU6-GAcc, and TU7-GAcc modes. This means that for UHD4K 10-bit test set, the MSS HEVC GAcc Encoder to achieve the same luma MS-SSIM quality as HM16.18 requires in TU4-GAcc mode 28.8% higher bitrate than HM16.18, in TU5-GAcc mode 42.1% higher bitrate than HM16.18, in TU6-GAcc mode 50.1% higher bitrate than HM16.18, and in TU7-GAcc mode 51.3% higher bitrate than HM16.18. For UHD4K 10-bit, in terms of comparing BD rate based on PSNR vs BD rate based on MS-SSIM, BD rate value based on MS-SSIM seems to be around 6-10% more for each TU's than the BD rate based

\*Other names and brands may be claimed as property of others.

on PSNR; as noted for CQp case, this is due to the fact that the visual quality improvement algorithms have yet to be extended and integrated for UHD4K 10-bit.

Table 16A shows for AVBR based coding the measured BD rate based on PSNR as percentage (for luma, and chroma components), and BD rate based on MS-SSIM as percentage (for luma component) difference of MSS HEVC Software Encoder over HM16.18 for each test sequence of UHD4K 10-bit test set shown in Table 11A for each of 5 TU modes (TU1, TU4, TU5, TU6, TU7) being evaluated.

Table 16A Quality comparison of **Media Server Studio HEVC Software Encoder** at various target usage (TU) settings with **MPEG HEVC HM 16.18 Encoder** on **UHD4K 10 bit** test set for adaptive variable bitrate (AVBR) based encoding. Two quality comparison metrics **BD rate** based on **PSNR** of luma and chroma, and **BD rate** based on **MS-SSIM** of luma are employed.

UHD4K 10 bit Test Set	TU1 AVBR		TU4 AVBR		TU5 AVBR		TU6 AVBR		TU7 AVBR	
	% BD Rate based on PSNR/MS-SSIM		% BD Rate based on PSNR/MS-SSIM		% BD Rate based on PSNR/MS-SSIM		% BD Rate based on PSNR/MS-SSIM		% BD Rate based on PSNR/MS-SSIM	
	Y	U/V	Y	U/V	Y	U/V	Y	U/V	Y	U/V
1 RollerCoaster	11.65	13.87/12.11	42.36	51.63/35.15	53.95	92.25/66.58	60.50	105.39/76.54	64.24	111.96/81.38
	17.29	-	50.05	-	65.45	-	71.51	-	75.42	-
2 Driving_POV	1.47	6.69/5.53	17.18	29.09/11.11	21.98	56.71/33.87	30.52	61.06/38.79	32.31	64.54/40.80
	5.78	-	21.75	-	26.63	-	36.13	-	38.07	-
3 Pier_SeaSide	5.82	-9.93/-12.39	17.37	7.07/-9.59	25.40	95.68/22.92	28.61	100.51/23.57	30.88	109.42/25.07
	27.02	-	35.14	-	40.54	-	42.19	-	47.27	-
4 Ritual_Dance	6.36	.06/-5.0	20.45	16.25/18.00	26.06	37.55/35.06	32.18	43.85/42.0	35.38	50.34/49.03
	9.06	-	22.47	-	28.28	-	34.06	-	36.84	-
5 SquareTimeLaps	6.59	-9.39/-7.81	22.23	4.07/6.55	27.94	20.20/22.86	35.53	25.62/28.16	38.18	29.09/32.49
	6.81	-	21.70	-	27.23	-	33.99	-	36.20	-
6 BarScene	-1.29	20.44/26.6	12.88	17.92/29.6	38.40	76.33/86.22	43.99	85.96/92.12	47.63	87.34/91.49
	2.49	-	12.12	-	52.64	-	52.72	-	59.04	-
Average	5.10	5.12/3.94	22.08	21.01/15.14	32.29	63.12/44.59	38.55	70.40/50.20	41.44	75.45/53.38
	11.41	-	27.20	-	40.13	-	45.10	-	48.81	-

As can be observed for UHD4K 10-bit content in AVBR based coding from Table 16A, average luma PSNR based BD rate percentage difference of MSS HEVC Software Encoder over HM16.18 is 5.1%, 22.1%, 32.3%, 38.6%, and 41.4% higher respectively for TU1, TU4, TU5, TU6, and TU7 modes. This means that for UHD4K 10-bit test set, for MSS HEVC Software Encoder in AVBR based coding to achieve the same luma PSNR quality as HM16.18 requires in TU1 mode 5.1% more bitrate as HM16.18, in TU4 mode 22.1% higher bitrate than HM16.18, in TU5 mode 32.3% higher bitrate than HM16.18, in TU6 mode 38.6% higher bitrate than HM16.18, and in TU7 mode 41.4% higher bitrate than HM16.18.

Further for UHD4K 10-bit test set in AVBR based coding from Table 16A also shows that the average luma MS-SSIM based BD rate percentage difference of MSS HEVC Software Encoder over HM16.18 is 11.4%, 27.2%, 40.1%, 45.1%, and 48.8% higher respectively in TU1, TU4, TU5, TU6, and TU7 modes. This means that for UHD4K 10-bit test set, the MSS HEVC Software Encoder to achieve the same luma PSNR quality as HM16.18 requires in TU1 mode 11.4% more bitrate than HM16.18, in TU4 mode 27.2% higher bitrate than HM16.18, in TU5 mode 40.1% higher bitrate than HM16.18, in TU6 mode 45.1% higher bitrate than HM16.18 in TU6, and in TU7 mode 48.8% higher bitrate than HM16.18. For UHD4K 10-bit, in terms of comparing BD rate based on PSNR vs BD rate based on MS-SSIM, BD rate value based on MS-SSIM seems to be around 6-8% more for each TU's than the BD rate based on PSNR; as noted for CQp case, this is due to the fact that the visual quality improvement algorithms have yet to be extended and integrated for UHD4K 10-bit.

Table 16B shows for AVBR based coding the measured BD rate based on PSNR as percentage (for luma, and chroma components), and BD rate based on MS-SSIM as percentage (for luma component) difference of MSS HEVC GAcc Encoder over HM16.18 for each test sequence of UHD4K 10-bit test set shown in Table 11A for each of 4 TU modes (TU4-GAcc, TU5-GAcc, TU6-GAcc, TU7-GAcc) being evaluated.

Table 16B Quality comparison of **MSS HEVC GACC Encoder** at various target usage (TU) settings with **MPEG HEVC HM 16.18 Encoder** on **UHD4K 10 bit** test set for adaptive variable bitrate (AVBR) based encoding. Two quality comparison metrics **BD rate** based on **PSNR** of luma and chroma, and **BD rate** based on **MS-SSIM** of luma are employed.

UHD4K 10 bit Test Set	TU4-GAcc AVBR		TU5-GAcc AVBR		TU6-GAcc AVBR		TU7-GAcc AVBR	
	% BD rate based on PSNR/MS-SSIM		% BD rate based on PSNR/MS-SSIM		% BD rate based on PSNR/MS-SSIM		% BD rate based on PSNR/MS-SSIM	
	Y	U/V	Y	U/V	Y	U/V	Y	U/V
1 RollerCoaster	32.73	36.79/22.63	42.53	80.00/53.89	52.39	90.87/63.23	53.80	96.19/66.77
	38.76	-	52.15	-	60.58	-	62.20	-
2 Driving_POV	21.27	32.73/15.22	24.78	64.40/40.67	33.93	64.62/42.36	36.02	68.08/43.66
	26.68	-	30.77	-	40.54	-	42.97	-
3 Pier_SeaSide	17.57	8.71/-8.19	23.94	119.69/24.61	26.72	117.94/19.87	28.94	117.52/20.67
	35.94	-	40.77	-	42.02	-	46.70	-
4 Ritual_Dance	19.06	13.89/15.46	23.94	31.13/31.29	29.95	36.99/37.6	32.88	42.64/43.65
	20.85	-	26.09	-	31.44	-	34.14	-
5 SquareTimeLapse	23.81	4.89/7.07	28.87	21.91/24.54	37.09	26.93/29.60	40.06	31.14/34.23
	23.26	-	28.17	-	35.39	-	37.97	-
6 BarScene	17.75	27.57/35.98	42.64	95.32/102.07	47.46	86.59/89.96	49.86	87.67/89.62
	15.06	-	55.15	-	58.16	-	58.40	-
Average	22.03	20.76/14.69	31.12	68.74/46.18	37.92	70.66/47.11	40.26	73.87/49.77
	26.76	-	38.85	-	44.69	-	47.06	-

\*Other names and brands may be claimed as property of others.

As can be observed for UHD4K 10-bit content for AVBR based coding from Table 16B, average luma PSNR based BD rate percentage difference of MSS HEVC GAcc Encoder over HM16.18 is 22.0%, 38.9%, 44.7%, and 47.1% higher respectively for TU4-GAcc, TU5-GAcc, TU6-GAcc, and TU7-GAcc modes. This means that for UHD4K 10-bit test set, for MSS HEVC GAcc Encoder in VBR based coding to achieve the same luma PSNR quality as HM16.18 requires in TU4-GAcc mode 22.0% higher bitrate than HM16.18, in TU5-GAcc mode 38.9% higher bitrate than HM16.18, in TU6-GAcc mode 44.7% higher bitrate than HM16.18, and in TU7-GAcc mode 47.1% higher bitrate than HM16.18. These PSNR based quality numbers for MSS HEVC GAcc Encoder are almost the same as the numbers of MSS HEVC Software Encoder.

Again, for UHD4K 10-bit test set undergoing AVBR coding, Table 16B also shows that the average luma MS-SSIM based BD rate percentage difference of MSS HEVC GAcc Encoder over HM16.18 is 26.8%, 38.9%, 44.7%, and 47.1% higher respectively in TU4-GAcc, TU5-GAcc, TU6-GAcc, and TU7-GAcc modes. This means that for UHD4K 10-bit test set, the MSS HEVC GAcc Encoder to achieve the same luma MS-SSIM quality as HM16.18 requires in TU4-GAcc mode 26.8% higher bitrate than HM16.18, in TU5-GAcc mode 38.9% higher bitrate than HM16.18, in TU6-GAcc mode 44.7% higher bitrate than HM16.18, and in TU7-GAcc mode 47.1% higher bitrate than HM16.18. For UHD4K 10-bit, in terms of comparing BD rate based on PSNR vs BD rate based on MS-SSIM, BD rate value based on MS-SSIM seems to be around 4-7% more for each TU's than the BD rate based on PSNR; as noted for CQp case, this is due to the fact that the visual quality improvement algorithms have yet to be extended and integrated for UHD4K 10-bit.

Table 17 summarizes the results of CQp and all BRC Modes for various TU settings of MSS HEVC Software and MSS HEVC GAcc Encoders.

Table 17 Summary of quality comparison of **Media Server Studio HEVC Software Encoder**, and **MSS HEVC GACC Encoder** at various target usage (TU) settings with **MPEG HEVC HM 16.18 Encoder** on **UHD4K 10 bit** test set for CQp/various bitrate control settings for encoding. Quality metrics employed are **BD rate based on PSNR** and **BD rate based on MS-SSIM**.

BRC	SW/GAcc	TU1		TU4/TU4-GAcc		TU5/TU5-GAcc		TU6/TU6-GAcc		TU7/TU7-GAcc	
		% BD Rate based on PSNR/MS-SSIM		% BD Rate based on PSNR/MS-SSIM		% BD Rate based on PSNR/MS-SSIM		% BD Rate based on PSNR/MS-SSIM		% BD Rate based on PSNR/MS-SSIM	
		Y	U/V	Y	U/V	Y	U/V	Y	U/V	Y	U/V
1	CQp SW	4.40	1.23/3.80	19.83	14.01/12.62	30.20	52.11/39.07	36.53	58.46/44.5	38.82	60.55/46.43
		4.94	-	18.50	-	31.58	-	37.19	-	39.66	-
2	CQp GAcc			19.95	13.35/11.66	29.69	58.23/40.62	36.92	56.91/42.18	38.60	61.25/43.99
				18.70	-	31.80	-	38.37	-	40.02	-
3	CBR SW	7.14	-2.09/-1.63	23.07	12.02/9.37	27.39	40.69/28.15	41.02	54.18/39.61	43.07	57.22/41.58
		14.94	-	29.91	-	36.15	-	50.82	-	53.21	-
4	CBR GAcc			23.04	10.93/8.23	32.08	50.89/34.81	40.32	52.29/36.68	41.81	55.95/37.98
				29.30	-	42.46	-	50.48	-	51.75	-

5	VBR	SW	6.88	-2.09/-1.62	22.77	11.93/9.29	33.54	48.53/34.23	40.70	54.21/39.66	42.70	57.17/41.53
			14.60	-	29.5	-	44.03	-	50.36	-	52.70	-
6	VBR	GAcc			22.69	10.83/8.15	31.83	51.05/34.96	40.00	52.29/36.70	41.43	55.91/37.92
					28.81	-	42.07	-	50.05	-	51.25	-
7	AVBR	SW	5.10	5.12/3.94	22.08	21.01/15.14	32.29	63.12/44.59	38.55	70.40/50.20	41.44	75.45/53.38
			11.41	-	27.20	-	40.13	-	45.10	-	48.81	-
8	AVBR	GAcc			22.03	20.76/14.6	31.12	68.74/46.18	37.92	70.66/47.11	40.26	73.87/49.77
					26.76	-	38.85	-	44.69	-	47.06	-

Now that we have completed quality analysis on UHD4K 10-bit content of MSS HEVC Software, and GAcc Encoders at various TU settings for CQp/various BRC modes, the next obvious step is to perform analysis of encoding speed offered by each of these modes; this issue is discussed at length in the next section.

## Intel Media Server Studio HEVC Encoder Quality vs Performance for UHD4K 10-bit

For measurement of encoding speed (fps) and speed vs quality tradeoffs, several recently released PC Platform based reference test systems are employed.

In Table T we list a number of recent processor and graphics systems that were used as test systems for performing the evaluation.

Table T System configurations (cfg) used in our Tests

cfg	System	Family	Class	Number of Cores	Base CPU Speed GHz	Memory (DRAM) GB	Graphi cs <sup>*</sup>	Base Graphics Speed MHz
1	i7-6970HQ	SkyLake	Mobile	4	2.8	16	GT4e	350
2	i7-6700K	SkyLake	Desktop	4	4.0	16	GT2	350
3	E3-1275v5	SkyLake	Server	4	3.6	32	GT2	300
4	i7-8700K	CoffeeLake	Workstation	6	3.7	16	GT2	350

\* Note that the graphics typem, ie, GT2, GT3, or GT4 implicitly indicates the number of execution units (EUs) supported on the system. For instance, GT4 is more capable than GT3 which is more capable than GT2 in terms of number of graphics processing capability (measured in EUs).

All systems employed use 16 GBytes of DRAM,except for E3-1275v5 that had 32 GB.

All Systems employed use Microsoft Win 10 Enterprise OS.

\*Other names and brands may be claimed as property of others.



## Performance on **cfg3** of MSS HEVC Software, and GAcc Encoders on UHD4K 10-bit

For encoding of UHD4K 10-bit content on test system **cfg3**, we measure encoding speed (fps) of MPEG HEVC HM16.18 Encoder, as well as our MSS HEVC Software Encoder on a number of TU settings. Results of these measurements comparing the two speeds are shown in Tables 18A and Table 8B.

From Table 18A, for MSS HEVC Software Encoder, average encoding speed for UHD4K 10-bit on test system **cfg3** is 2.7, 18.3, 32.6, 53.9, and 59.4 fps respectively in TU1, TU4, TU5, TU6, and TU7 modes.

Table 18A Average **Encoding Speed** performance (fps) of **Media Server Studio HEVC Software Encoder** at various target usage (TU) settings on **UHD4K 10 bit** test set for constant Qp (CQP) based encoding; results are for test system (CPU/GPU) configuration 3 (**cfg3**). For reference the average Speed of HM16.18 Encoder for this test set is .004 fps.

UHD4K 10 bit Test Set	TU1	TU4	TU5	TU6	TU7
	Enc Speed (cfg3)	Enc Speed (cfg3)	Enc Speed (cfg3)	Enc Speed (cfg3)	Enc Speed (cfg3)
	fps	fps	fps	fps	fps
1 RollerCoaster	0.62	4.05	7.35	10.31	10.91
2 Driving_POV	0.74	4.26	7.21	11.90	12.76
3 Pier_SeaSide	0.87	4.40	8.30	12.96	13.88
4 Ritual_Dance	0.44	3.79	6.81	9.92	10.59
5 SquareTimeLap	0.66	4.27	7.53	11.76	12.51
6 BarScene	1.06	4.24	8.76	12.87	13.68
<b>Average</b>	<b>0.73</b>	<b>4.17</b>	<b>7.66</b>	<b>11.62</b>	<b>12.39</b>

Likewise, from Table 18B, for MSS HEVC GAcc Encoder, average encoding speed for UHD4K 10-bit on test system **cfg4** is 31.9, 51.6, 90.9, and 99.1 fps respectively for TU4-GAcc, TU5-GAcc, TU6-GAcc, and TU7-GAcc.

Table 18B Average **Encoding Speed** performance (fps) of **MSS HEVC GAcc Encoder** at various target usage (TU) settings on **UHD4K 10 bit** test set for constant Qp (CQP) based encoding; results are for test system (CPU/GPU) configuration 3 (**cfg3**). For reference the average Speed of HM16.18 Encoder for this test set is .004 fps.

UHD4K 10 bit Test Set	TU4-GAcc	TU5-GAcc	TU6-GAcc	TU7-GAcc
	Enc Speed (cfg3)	Enc Speed (cfg3)	Enc Speed (cfg3)	Enc Speed (cfg3)
	fps	fps	fps	fps
1 RollerCoaster	8.13	11.46	16.26	16.94
2 Driving_POV	7.76	10.85	16.30	17.15
3 Pier_SeaSide	8.10	12.15	17.61	18.52
4 Ritual_Dance	7.49	10.65	15.60	16.47
5 SquareTimeLap	8.19	11.30	16.70	17.58
6 BarScene	8.33	12.84	18.29	19.14
<b>Average</b>	<b>8.00</b>	<b>11.54</b>	<b>16.79</b>	<b>17.63</b>

## Performance on **cfg4** of MSS HEVC Software, and GAcc Encoders on UHD4K 10-bit

For encoding of UHD4K 10-bit content on test system **cfg4**, we measure encoding speed (fps) of MPEG HEVC HM16.18 Encoder, as well as our MSS HEVC Software Encoder on a number of TU settings. Results of these measurements comparing the two speeds are shown in Tables 18C and Table 18D.

From Table 18C, for MSS HEVC Software Encoder, average encoding speed for UHD4K 10-bit on test system **cfg4** is 3.5, 24.4, 43.8, 69.3, and 75.9 fps respectively in TU1, TU4, TU5, TU6, and TU7 modes.

Table 18C Average **Encoding Speed** performance (fps) of **MSS HEVC Software Encoder** at various target usage (TU) settings on **UHD4K 10 bit** test set for constant Qp (**CQP**) based encoding; results are for test system (CPU/GPU) configuration 4 (**cfg4**). For reference the average Speed of HM16.18 Encoder for this test set is .004 fps.

UHD4K 10 bit Test Set	TU1	TU4	TU5	TU6	TU7
	Enc Speed (cfg4)	Enc Speed (cfg4)	Enc Speed (cfg4)	Enc Speed (cfg4)	Enc Speed (cfg4)
	fps	fps	fps	fps	fps
1 RollerCoaster	0.86	5.16	10.00	13.61	14.39
2 Driving_POV	1.03	5.69	10.13	16.38	17.46
3 Pier_SeaSide	1.30	6.05	12.31	18.94	20.26
4 Ritual_Dance	0.65	4.88	9.32	13.19	14.04
5 SquareTimeLap	0.83	5.33	9.78	14.53	15.49
6 BarScene	1.23	5.47	12.79	17.66	18.57
<b>Average</b>	<b>0.99</b>	<b>5.43</b>	<b>10.72</b>	<b>15.72</b>	<b>16.70</b>

Likewise, from Table 18D, for MSS HEVC GAcc Encoder, average encoding speed for UHD4K 10-bit on test system **cfg4** is 31.9, 51.6, 90.9, and 99.1 fps respectively fo TU4-GAcc, TU5-GAcc, TU6-GAcc, and TU7-GAcc.

Table 18D Average **Encoding Speed** performance (fps) of **MSS HEVC GAcc Encoder** at various target usage (TU) settings on **UHD4K 10 bit** test set for constant Qp (**CQP**) based encoding; results are for test system (CPU/GPU) configuration 4 (**cfg4**). For reference the average Speed of HM16.18 Encoder for this test set is .004 fps.

UHD4K 10 bit Test Set	TU4-GAcc	TU5-GAcc	TU6-GAcc	TU7-GAcc
	Enc Speed (cfg4)	Enc Speed (cfg4)	Enc Speed (cfg4)	Enc Speed (cfg4)
	fps	fps	fps	fps
1 RollerCoaster	10.68	14.14	20.36	20.80
2 Driving_POV	10.49	13.73	20.80	21.50
3 Pier_SeaSide	11.39	15.58	22.83	23.41
4 Ritual_Dance	10.03	13.47	19.98	20.52
5 SquareTimeLap	10.21	13.64	20.18	20.71
6 BarScene	11.16	15.89	22.40	23.19
<b>Average</b>	<b>10.66</b>	<b>14.41</b>	<b>21.09</b>	<b>21.69</b>

\*Other names and brands may be claimed as property of others.

## Encoding Speed comparison for different cfg's, and TU settings for UHD4K 10-bit

We first summarize in Table 19, results of our tests using different test systems on important TU settings for both MSS HEVC SW, and HEVC GAcc Encoders.

Table 19 Summary of **Encoding Speed** performance comparison of **MSS HEVC Software Encoder**, and **MSS HEVC GACC Encoder** at various target usage (TU) settings for different test system configurations (cfg3, cfg4) on UHD4K 10 bit test set for CQp based encoding. For reference the average Speed of HM16.18 Encoder for this test set is .004 fps.

Config	SW/GAcc	TU1	TU4/TU4-GAcc	TU5/TU5-GAcc	TU6/TU6-GAcc	TU7/TU7-GAcc
		Enc Speed	Enc Speed	Enc Speed	Enc Speed	Enc Speed
		fps	fps	fps	fps	fps
1	Cfg3 SW	0.73	4.17	7.66	11.62	12.39
2	Cfg3 GAcc		8.00	11.54	16.79	17.63
3	Cfg4 SW	0.99	5.43	10.72	15.72	16.70
4	Cfg4 GAcc		10.66	14.41	21.09	21.69

As can be seen from Table 19, for MSS HEVC Software Encoder, the fastest test system cfg4, can irrespective of the TU provide ~1.3x speedup as compared to the test system cfg2, and almost 2.1x speedup over test system cfg1.

Likewise from the same table, we can also observe that for a particular test system configuration, and TU setting the MSS HEVC GAcc Encoder can typically be 1.4x to 1.6x faster (in some cases, such as for test system cfg1, this factor is as much as 1.7x or even more) than the MSS HEVC Software Encoder. Further, as noted earlier, for a corresponding TU, the video quality/compression generated by the MSS HEVC GAcc Encoder is very similar to that of the MSS HEVC Software Encoder's video quality/compression. This would seem to indicate that the MSS HEVC GAcc Encoder is sufficient, however it would seem to make the MSS HEVC Software Encoder somewhat redundant. In reality, there are a number of reasons that the MSS HEVC Software Encoder is also necessary; these reasons are discussed next.

Also from Table 19 it can be seen that the super-high quality setting TU1 only exists for Media Server Studio HEVC Software Encoder (and not for HEVC GAcc Encoder); this has to do with the type of tradeoffs that lend themselves to provide good speedup for HEVC GAcc Encoder, are not the best ones to help achieve super-high quality – for that you need different tradeoff approaches that are best in pure software. There are additional reasons also such that in some environments instead of graphics/GPU, the emphasis is on large number of cores, which means that HEVC GAcc Encoder would not work there and one would need the HEVC Software Encoder.

One other thing to observe is that the fastest combination of test systems, codec, and TU settings allows average encoding speeds of almost 100 fps for 1080p coding.

Fig. 12A shows bar-graphs comparing the performance of each of the key TU modes as well as wrt MPEG HM 16.18 (with its speed also shown on the same figure) of each of the key TU modes of MSS HEVC Software Encoder on test system *cfg2*. Specifically, for 1080p encoding, the average speed of MSS HEVC Software Encoder for TU1, TU4, TU5, TU6, and TU7 is shown respectively to be 2.7 fps, 18.3 fps, 32.6 fps, 53.9 fps, and 59.4 fps.

Further from Fig. 12A it can also be seen that on test system *cfg2* the encoding speed of MSS HEVC Software Encoder wrt HM16.18 encoder for encoding of 1080p content is 90x, 608x, 1086x, 1795x, and 1978x in TU1, TU4, TU5, TU6, and TU7 modes respectively. Thus, encoding at TU1 is 90x, and TU4 – TU7 is in range of 600x to 2000x (multithreaded on 4 cores) the speed of HM16.18 (single threaded/1 core). Earlier we had shown that the quality of TU1 mode is nearly identical (based both PSNR based BD rate, and MS-SIM based BD rate) to quality of HM16.18.

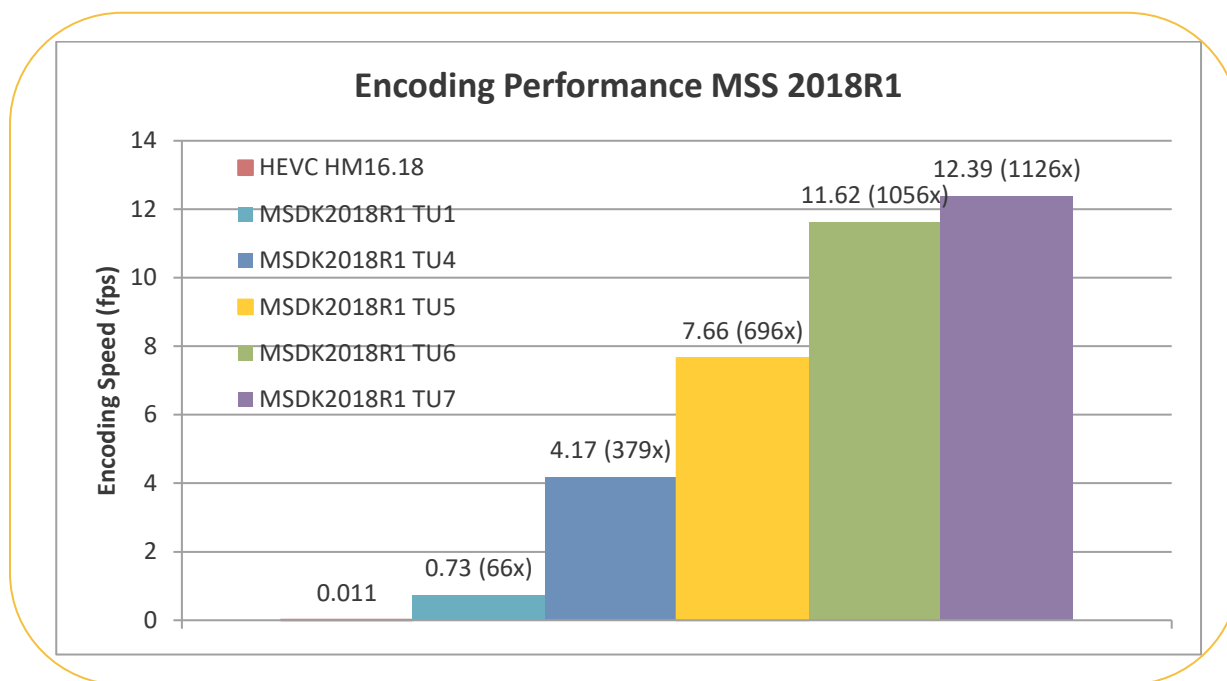

Figure 12A Average speed of encoding of HM reference, and MSS HEVC Software Encoder for TU settings of TU1, TU4, TU5, TU6, and TU7, for encoding of HD 1080p content on test system configuration 3 (*cfg3*).

Fig. 12B shows bar-graphs comparing the performance of each of the key TU modes as well as wrt MPEG HM 16.18 (with its speed also shown on the same figure) of each of the key TU modes of MSS HEVC GAcc Encoder on test system *cfg2*. Specifically, for 1080p encoding, the average speed of MSS HEVC GAcc Encoder for TU4, TU5, TU6, and TU7 is shown respectively to be 29.1 fps, 45.6 fps, 76.6 fps, and 59.4 fps.

Further from Fig. 12B it can also be seen that on test system *cfg2* the encoding speed of MSS HEVC GAcc Encoder wrt HM16.18 encoder for encoding of 1080p content is 969x, 1520x, 2554x, and 2755x in TU4-GAcc, TU5-GAcc, TU6-GAcc, and TU7-GAcc modes respectively. Thus, encoding at TU4-GAcc – TU7-GAcc is in range

\*Other names and brands may be claimed as property of others.

of 900x to 2750x (multithreaded on 4 cores) the speed of HM16.18 (single threaded/1 core). Earlier we had shown that the quality of TU4-GAcc mode is ‘very good’ if not identical to quality of HM16.18.

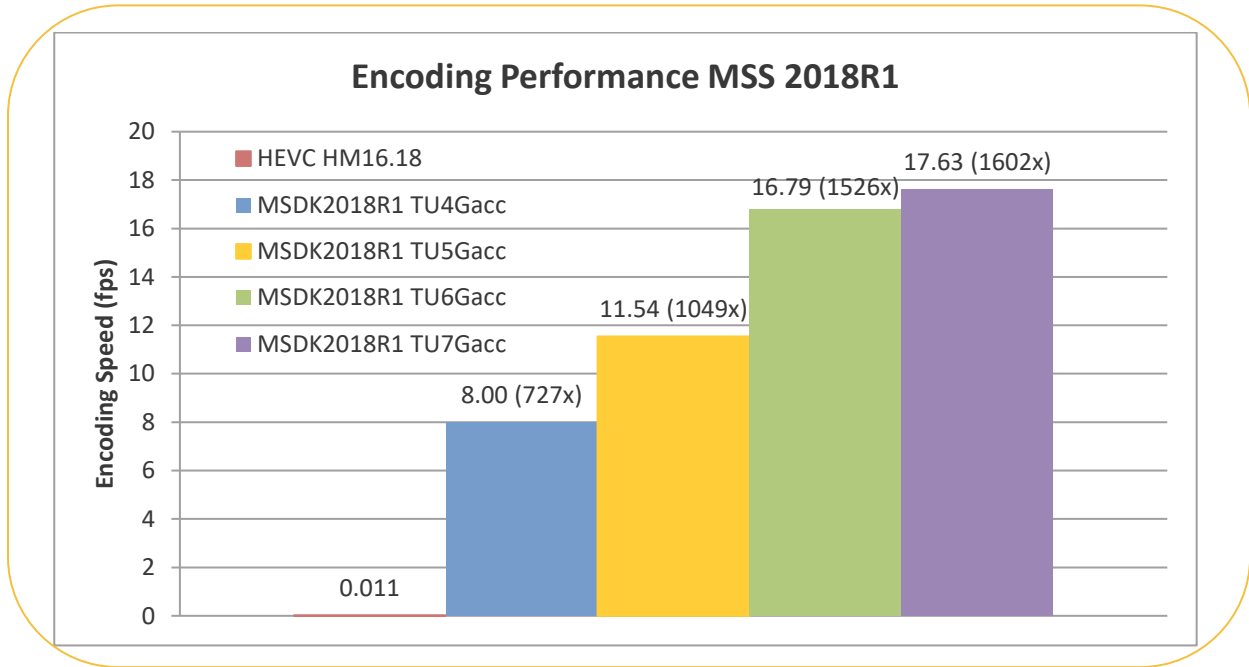

Figure 12B Average speed of encoding of HM reference, and MSS HEVC GAcc Encoder for TU settings of TU4, TU5, TU6, and TU7, for encoding of UHD4K content on test system configuration 3 (cfg3).

## CPU Load Comparison of Media Server Studio HEVC Software, and GAcc Encoders on UHD4K 10-bit

We now discuss the issue of CPU load when running HEVC encoding with MSS HEVC Software, and MSS HEVC GAcc Encoders. A high CPU load may suggest that available CPU's are being used effectively, however if the CPU load is too high, it can also indicate that the system is rather overloaded and unable to perform any other task including system management tasks comfortably.

Fig. 13A shows on test system *cfg2*, the load comparison of MSS HEVC Software, and MSS HEVC GAcc Encoders for various TU settings. Specifically, the CPU load %age of MSS HEVC Software Encoder is shown for TU settings of TU1, TU4, TU5, TU6, and TU7 to be 94.4, 97.1, 98.1, 96.4, and 95.4 respectively. Further, the CPU load %age of MSS HEVC GAcc Encoder is also shown but for TU settings of TU4-GAcc, TU5-GAcc, TU6-GAcc, and TU7-GAcc to be 84.9, 88.5, 91.9, 91.4 respectively. This means that MSS HEVC GAcc Encoder is able to free up CPU load of 5 to 10 %age as compared to MSS HEVC Software Encoder allowing normal system functions to function; this is in addition to MSS HEVC GAcc Encoder being 1.4x to 1.6x faster while at the same quality.

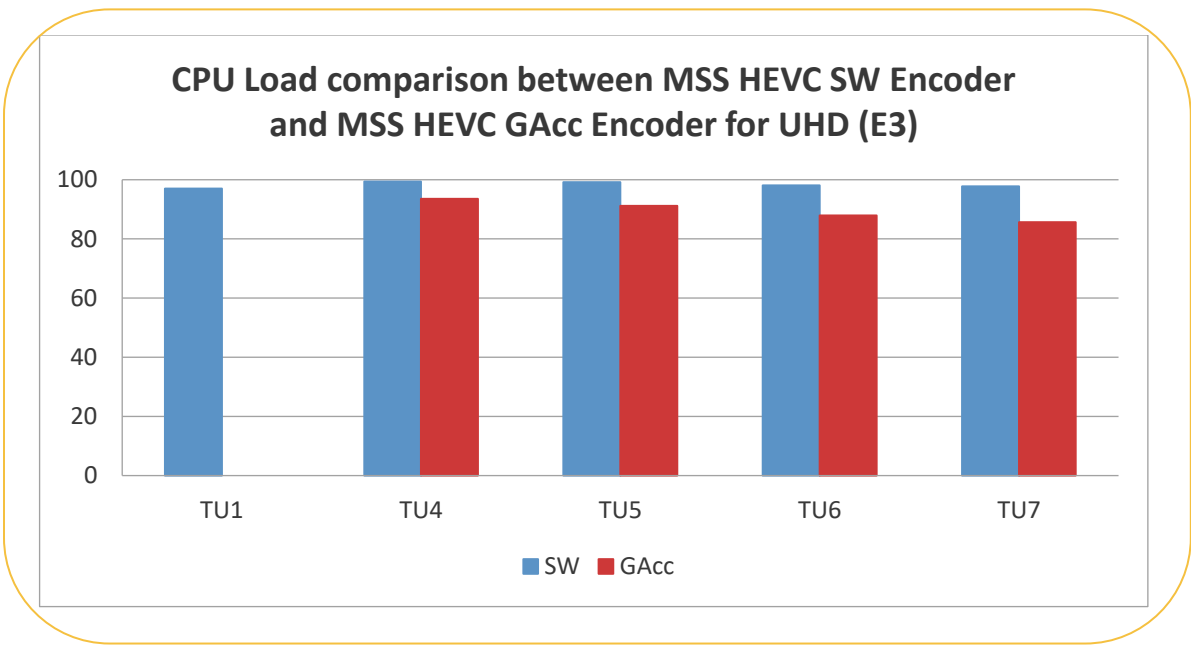

Figure 13A CPU Load Difference in UHD4K encoding between MSS HEVC Software Encoder and MSS HEVC GAcc Encoder at different TU modes on test system configuration 3 (cfg3).

Next, Fig. 13B shows a similar load comparison but on test system *cfg4* which has more cores (6) as compared to 4 coes in test system *cfg2*. Here we observe that the CPU load %age is typically lower by 15-20% depending on the TU for MSS HEVC GAcc Encoder over same TU of MSS HEVC Software Encoder

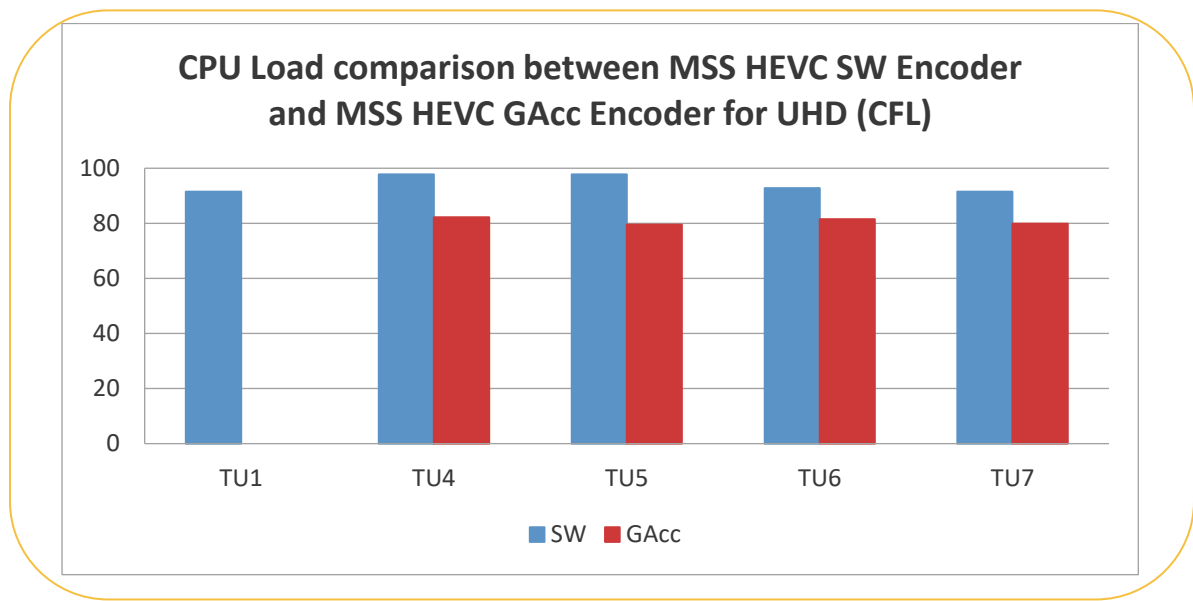

Figure 13B CPU Load Difference in UHD4K encoding between MSS HEVC Software Encoder and MSS HEVC GAcc Encoder at different TU modes on test system configuration 4 (cfg4).

\*Other names and brands may be claimed as property of others.

## Quality vs Performance Tradeoff of MSS HEVC Software, and GAcc Encoders for UHD4K 10-bit

We now discuss the overall Codec Quality vs Encoding Performance results for both the MSS HEVC Software, and MSS HEVC GAcc Encoders for various TU settings that they support.

Fig. 14A shows for test system *cfg2*, comparison of Quality in the units of negative Y PSNR based BD rate %age wrt HEVC HM16.18 (smaller is better) vs Encoding Performance (fps) for each of the the five TU settings - TU1, TU4, TU5, TU6, and TU7 for the MSS HEVC Software Encoder and the four TU settings – TU14-GAcc, TU5-GAcc, TU6-GAcc, and TU7-GAcc for the MSS HEVC GAcc Encoder. The y-axis basically shows the quality difference in terms of loss of BD rate percentage difference in the process of increasing speed up of the encoder in going from TU1 to TU4 to TU5 to TU6 to TU7 operating points for MSS HEVC Software Encoder, and TU4-GAcc to TU5-GAcc to TU6-GAcc to TU7-GAcc operating points for MSS HEVC GAcc Encoder. The quality values per TU were obtained from Table 7 whereas the performance values were obtained from Table 9.

From Fig. 14A, we can clearly see that for any given quality corresponding to TU4 and above, the encoding speed provided by MSS HEVC GAcc Encoder is significantly faster than that by MSS HEVC Software Encoder.

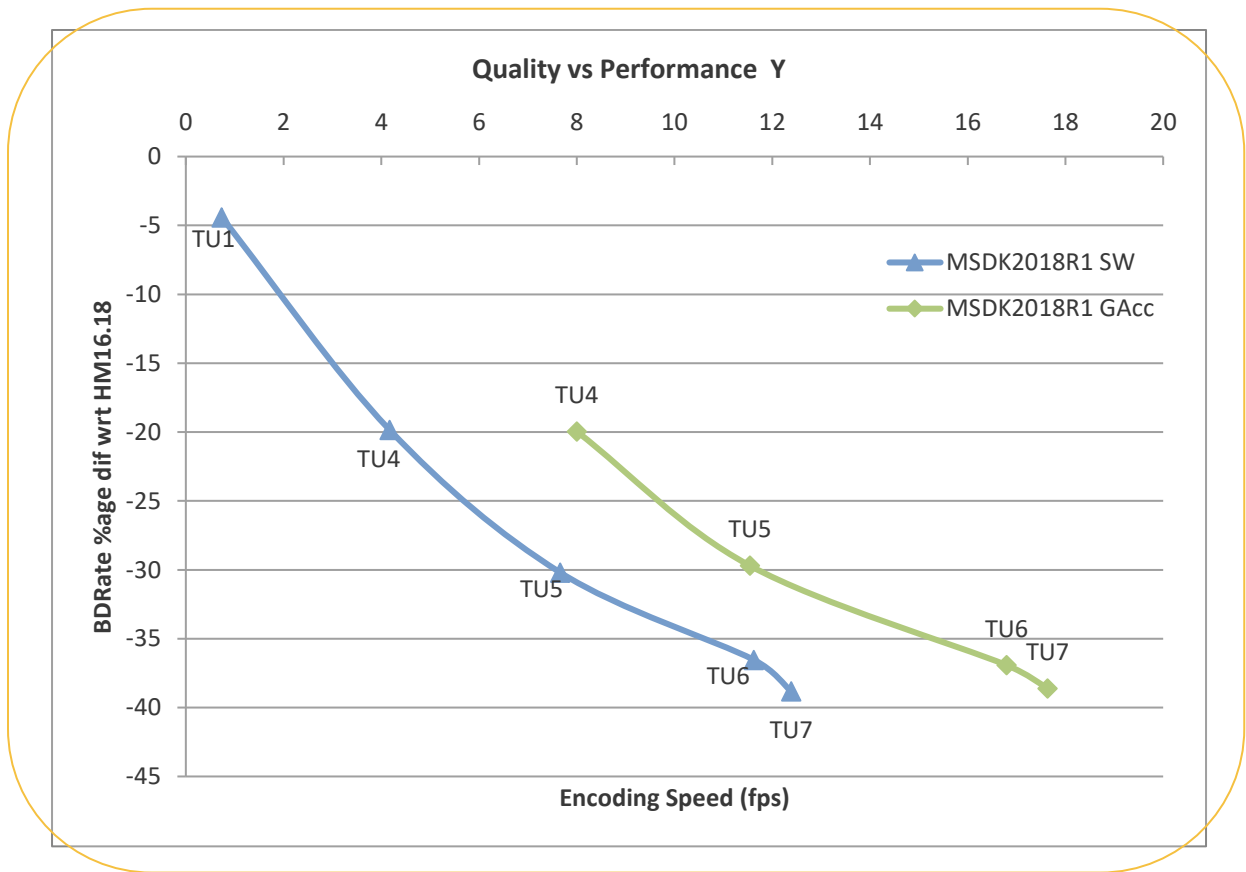

Figure 14A Quality (Y PSNR based BD rate wrt HM16.18) vs Encoding Speed Tradeoff in encoding of UHD4K content by MSS HEVC Software, and MSS HEVC GAcc Encoders in different TU modes, on test system configuration 3 (*cfg3*)

Fig. 14B similarly shows for test system *cfg2*, comparison of Quality in the units of negative MS-SSIM based BD rate %age wrt HEVC HM16.18 (smaller is better) vs Encoding Performance (fps) for each of the the five TU settings - TU1, TU4, TU5, TU6, and TU7 for the MSS HEVC Software Encoder and the four TU settings – TU14-GAcc, TU5-GAcc, TU6-GAcc, and TU7-GAcc for the MSS HEVC GAcc Encoder. The quality values per TU were obtained from Table 7 whereas the performance values were obtained from Table 9.

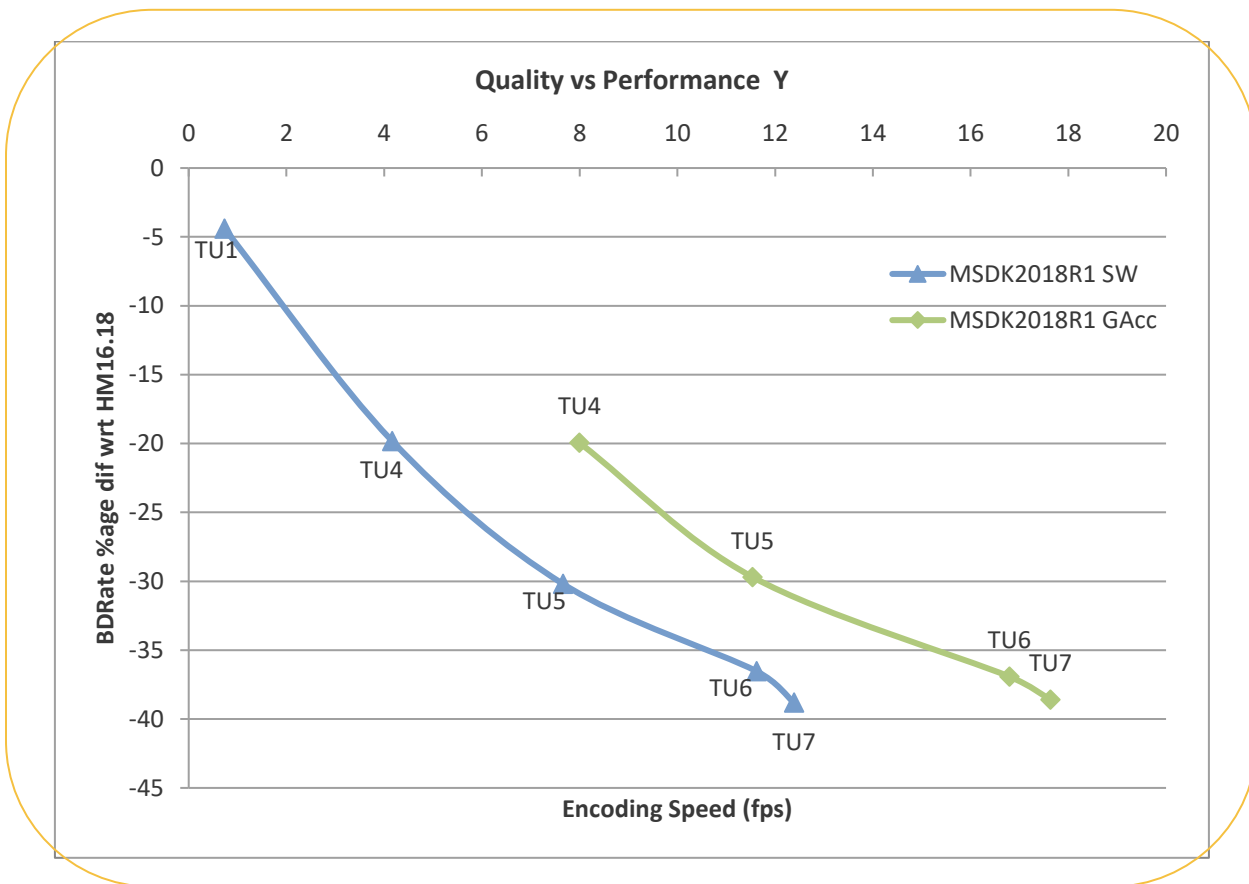

Figure 14B Quality (Y MS-SSIM based BD rate wrt HM16.18) vs Encoding Speed Tradeoff in encoding of UHD4K content by MSS HEVC Software, and MSS HEVC GAcc Encoders in different TU modes, on test system configuration 3 (*cfg3*)

To summarize, encoding performance-wise MSS HEVC Software, and MSS HEVC GAcc Encoders in different TU modes achieves the following speedup of HEVC encoding on test system *cfg2*, the 4 core Reference PC platform specified earlier.

- On test system *cfg2* and for UHD4K 10-bit test set, MSS HEVC Software Encoder in TU1, TU4, TU5, TU6, and TU7, correspondingly on average provides 2.7 fps, 18.3 fps, 32.6 fps, 53.9 fps, and 59.4 fps. This reflects for the five TU's corresponding speedup factors wrt HM16.18 of 90, 608, 1086, 1795, and 1978.
- On test system *cfg2* and for UHD4K 10-bit test set, MSS HEVC GAcc Encoder in TU4-GAcc, TU5-GAcc, TU6-GAcc, and TU7-GAcc, correspondingly on average provides 29.1 fps, 45.6 fps, 76.6 fps, and 82.7 fps. This reflects for the four TU's corresponding speedup factors wrt HM16.18 of 969, 1520, 2554, and 2755

\*Other names and brands may be claimed as property of others.



## Intel® MSS HEVC Software Decoder Performance for UHD4K 10-bit

In this section we describe results of performance measurement of decoding by Intel® MSS HEVC Decoder, encoded UHD4K 10 bit bitstreams. For measurement of decoding speed (fps), the test system cfg3 used for encoding speed measurement, is employed.

The MSS HEVC Software Decoder is able to achieve very high threading throughput consuming over 90% of resources on the noted machine.

For measurement of decoder performance, longer bitstreams of around 1000 or more frames are necessary to obtain a stable measurement. Thus, each of the video sequences of since they are relatively short were extended by palindromic repetition (so as not to introduce sudden scene changes that might introduce an unnatural behavior in the measurement) to 1200 frames long and compressed with MSS HEVC Software or GAcc Encoders using the same Qp quantizers as in Table 11A. These longer compressed streams were then used for decoder performance measurement.

Tables 20A shows for test system cfg3, average bitstream decoding speed for bitstreams generated from encoding each sequence of UHD4K 10 bit test set by MSS HEVC Software Encoder in each of its TU (TU1, TU4, TU5, TU6, TU7) modes.

Table 20A Average **Decoding Speed** performance (fps) of **MSS HEVC Software Decoder** decoding on test system configuration 3 (cfg3), streams of **UHD4K 10 bit** test set encoded at constant Qp (CQP) by **MSS HEVC Software Encoder** in various TU modes.

UHD4K 10 bit Test Set	TU1	TU4	TU5	TU6	TU7
	Dec Speed (cfg3)	Dec Speed (cfg3)	Dec Speed (cfg3)	Dec Speed (cfg3)	Dec Speed (cfg3)
	fps	fps	fps	fps	fps
1 RollerCoaster	105.09	100.63	104.43	104.05	108.42
2 Driving_POV	101.41	98.15	100.38	100.62	104.31
3 Pier_SeaSide	113.97	108.57	111.91	111.59	116.25
4 Ritual_Dance	100.01	97.95	100.12	99.53	103.22
5 SquareTimeLap	104.62	102.63	104.67	104.83	108.88
6 BarScene	115.43	108.67	114.09	113.91	119.59
<b>Average</b>	<b>106.76</b>	<b>102.77</b>	<b>105.93</b>	<b>105.75</b>	<b>110.11</b>

Tables 20B shows for test system cfg3, average bitstream decoding speed for bitstreams generated from encoding each sequence of UHD4K 10 bit test set by MSS HEVC GAcc Encoder in each of its TU (TU4-GAcc, TU5-GAcc, TU6-GAcc, TU7-GAcc) modes.

Table 20B Average **Decoding Speed** performance (fps) of **MSS HEVC Software Decoder** decoding on test system configuration 3 (cfg3), streams of **UHD4K 10 bit** test set encoded at constant Qp (CQP) by **MSS HEVC GAcc Encoder** in various TU modes.

UHD4K 10 bit Test Set	TU4-GAcc	TU5-GAcc	TU6-GAcc	TU7-GAcc
	Dec Speed (cfg3)	Dec Speed (cfg3)	Dec Speed (cfg3)	Dec Speed (cfg3)
	fps	fps	fps	fps
1 RollerCoaster	100.88	103.50	107.80	107.99
2 Driving_POV	98.10	100.02	103.97	103.93
3 Pier_SeaSide	109.42	111.94	116.29	116.31
4 Ritual_Dance	98.24	99.55	103.15	103.02
5 SquareTimeLap	103.52	104.90	108.74	108.77
6 BarScene	109.73	114.38	119.53	119.67
<b>Average</b>	<b>103.31</b>	<b>105.71</b>	<b>109.91</b>	<b>109.95</b>

As can be seen from Table 10A-10B, as expected, the decoding speed to some extent depends on corresponding TU setting used for software or GAcc encoder; in other words, decoding speed is bit slower for lower TU values (such as TU1 or TU4), and higher for higher TU's (such as TU7). However, the difference in decoding speed is not significant for same TU for software and GAcc encoders (such as TU4 and TU4-GAcc). Overall, for test system cfg2, by using maximum benefit of threading, typical decoding speed for UHD4K 10 bit video is within the range of 100-110 fps.

Fig. 15 shows comparison of decoding performance on test system cfg3 for each of TU encoded bitstreams generated by MSS HEVC Software Encoder.

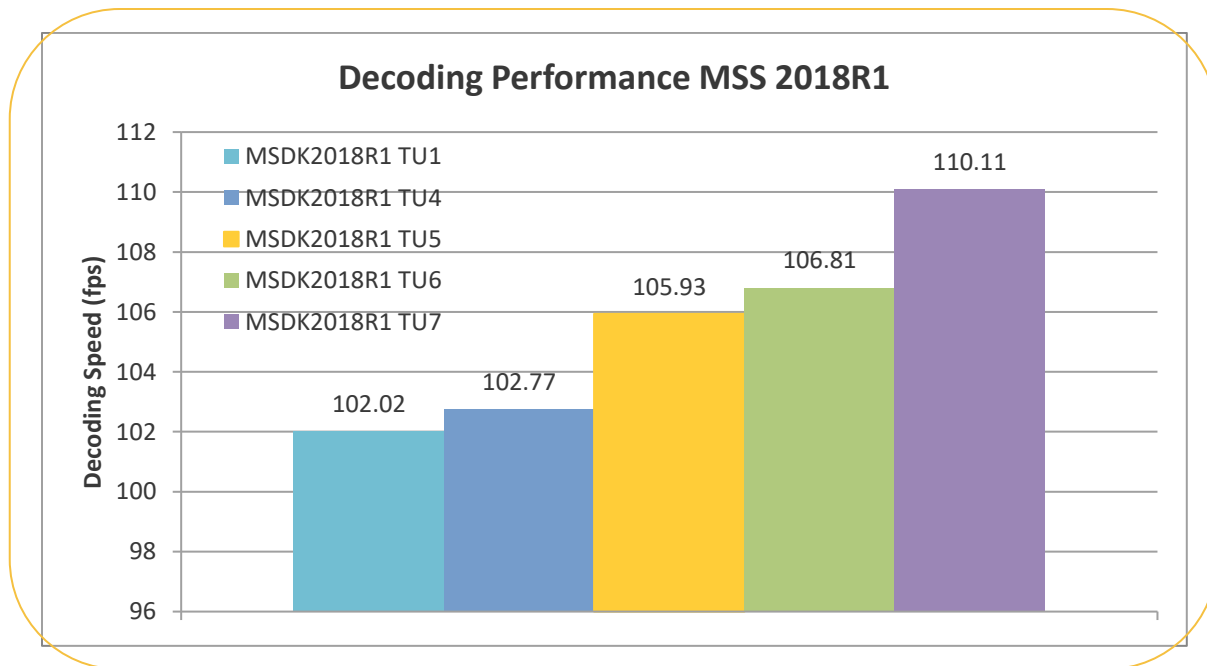

Figure 15 Average decoding speed on test system configuration 3 (cfg3), of of UHD4K content encoded by MSS HEVC Software Encoder for TU settings of TU1, TU4, TU5, TU6, and TU7.

\*Other names and brands may be claimed as property of others.

## Summary

Since publication of the previous white paper (version 1.6), a key trend leading up to this new release of Intel Media Server Studio HEVC Software, and HEVC Graphic Accelerated Encoders, is coding adaptation for improvement of subjective/perceptual video quality.

The above noted trend necessitated development and integration of a number of key technologies such as the following that were gradually added over the noted time period. Most of these features are currently available for improving HD1080p video coding, but have yet to be adapted for UHD4K 10-bit encoding; this should happen in the next release.

- Improved of subjective quality by content adaptive partitioning and mode decision.
- Improved quantization for HEVC Encoding including use of lambda quantization as well as persistence based quantization
- Implemented Human region of Interest (HROI) and its support via detection of Face/Skin tones
- Added Human Visual System (HVS) sensitive psycho-quantization has now been integrated.

Along with adding these tools there came a need to add a trackable basis for quality measurement that may be closer to subjective quality; to address this requirement, after considerable investigation, calculation of MS-SSIM quality metric, and MS-SSIM based BD-rate was added as a measure of Rate vs subjective distortion tradeoff (in addition to previously use normal rate-distortion tradeoff based on PSNR). This version of white paper has shown both BD-rate measurements for the 1080p 8-bit, and UHD4K 10-bit data-sets. Finally with applications requiring different types of coding under various bit-rate control methods was performed and evaluate. As a result the following actions were taken.

- A streamlined methodology for quality testing is now employed. For testing 4K 10-bit content, a new test set (based on AOM AV1 development) is defined and used.
- Quality analysis is now based on both PSNR, and MS-SSIM metrics that are used to calculate respective BD-rates.
- A number of bit-rate control modes are now supported such as CBR, VBR, and AVBR. Along with constant Qp (CQp), these BRC modes are evaluated in this white paper for their effectiveness.

In addition, this release was validated for performance on a range of recent Intel® mobile, desktop, workstation and server platforms.

Another recent trend over the same has been increased emphasis on reducing latency and improving quality for live encoding. Further for live encoding some applications require improved interlaced video coding support. As a result the following actions were taken.

- Reduced Live Encoding Latency and improved quality for Live encoding applications (the testing of this feature is however outside the scope of this white
- Improved interlaced video coding in terms of reduced latency, as well as improved quality.

Collectively as a result of noted actions, Intel Media SDK HEVC Encoders now meets market needs in a range of highly demanding scenarios, one end of which is very high quality applications, and the other end of which is high performance applications. Further, live applications with strict requirements are also handled better now.

## References

- [1] G. Sullivan, J.-R. Ohm, W.-J. Han, T. Wiegand, “Overview of the High Efficiency Video Coding (HEVC) Standard,” IEEE Transactions on Circuits and Systems for Video Technology, Vol. 22, No. 12, pp 1649-1668, Dec 2012.
- [2] JCT-VC Video Subgroup Editors, “ISO/IEC JTC1/SC29/WG11 MPEG 2012/N13154: HM9 High Efficiency Video Coding (HEVC) Test Model 9 Encoder Description,” Oct. 2012, Shanghai.
- [3] Joint Collaborative Team on Video Coding, “JCTVC-L1003\_v34: High Efficiency Coding Video Coding (HEVC) Text specification draft 10,” Jan. 2013, Geneva.
- [4] Leonardo Chiariglione (Ed.), “The MPEG Representation of Digital Media,” Springer, ISBN 978-1-4419-6183-9, 2012.
- [5] J. Wang, X. Yu, D. He, “JCTVC-F270: On BD-Rate Calculation,” Jul 2011, Torino. *Also based on ...*J. Zhao, Y. Su, A. Segall, “ITU-T COM16-C-404: On the Calculation of PSNR and bit-rate differences for the SVT test data,” April 2008.
- [6] A. Puri, X. Chen, A. Luthra, “Video Coding using the H.264/MPEG-4 AVC Compression Standard,” Signal Processing Image Communication, pp. 793-849, 2004.
- [7] T. Daede, A. Norkin, I. Brailovskiy, “Video Codec Testing and Quality Measurement,” Network Working Group, Internet-Draft, draft-ietf-netvc-testing-03, IETF, July 2016.

## Appendix A

### Summary of Quality and Performance on HD1080p 8-bit content

#### Video Quality of MSS HEVC Software Encoder on HD1080p 8-bit

BRC mode	Quality Metric for Y BD rate	Quality difference (Y BD rate %) of Target Usage (TU) mode with respect to HM16				
		TU1	TU4	TU5	TU6	TU7
CQp	PSNR	1.5	14.7	19.5	25.1	27.3
	MS-SSIM	0.4	13.2	18.8	23.7	25.9
CBR	PSNR	5.4	18.3	22.7	29.2	30.6
	MS-SSIM	3.4	15.6	20.3	25.1	27.6
VBR	PSNR	5.0	17.8	22.4	27.9	30.2
	MS-SSIM	3.4	15.5	20.6	25.3	27.7
AVBR	PSNR	3.4	16.1	21.4	26.4	28.8
	MS-SSIM	1.0	13.3	19.2	23.5	26.0

#### Video Quality of MSS HEVC GAcc Encoder on HD1080p 8-bit

BRC mode	Quality Metric for Y BD rate	Quality difference (Y BD rate %) with HM16 of Target Usage (TU) mode with respect to HM16				
			TU4-GAcc	TU5-GAcc	TU6-GAcc	TU7-GAcc
CQp	PSNR		15.1	19.7	24.4	26.4
	MS-SSIM		13.5	19.3	21.6	23.6
CBR	PSNR		19.5	23.9	28.2	30.3
	MS-SSIM		12.3	17.4	19.8	21.9
VBR	PSNR		19.1	23.5	27.9	30.1
	MS-SSIM		12.4	17.6	20.0	22.2
AVBR	PSNR		17.2	22.5	27.5	29.6
	MS-SSIM		10.3	16.2	19.3	21.3

### Encoding Speed of MSS HEVC Software Encoder on HD1080p 8-bit

BRC mode	Test System configuration	Average Encoding Speed Performance (fps) in Target Usage (TU) mode				
		TU1	TU4	TU5	TU6	TU7
CQp	cfg1	1.5	11.3	20.2	33.6	37.6
	cfg2	2.7	18.3	32.6	53.9	59.4
	cfg3	2.6	18.0	31.8	52.7	58.2
	cfg4	3.5	24.4	43.8	69.3	75.9

### Encoding Speed of MSS HEVC GAcc Encoder on HD1080p 8-bit

BRC mode	Test System configuration	Average Encoding Speed Performance (fps) in Target Usage (TU) mode				
			TU4-GAcc	TU5-GAcc	TU6-GAcc	TU7-GAcc
CQp	cfg1		21.0	34.2	53.7	59.5
	cfg2		29.1	45.6	76.6	82.7
	cfg3		29.2	46.3	74.0	80.5
	cfg4		31.9	51.6	90.9	99.1

### Decoding Speed of Decoder on MSS HEVC Software Encoded HD1080p 8-bit

BRC mode	Test System configuration	Average Decoding Speed Performance (fps) of bitstream generated by Target Usage (TU) mode				
		TU1	TU4	TU5	TU6	TU7
CQp	cfg2	380.6	413.2	430.3	438.6	449.3

### Decoding Speed of Decoder on MSS HEVC GAcc Encoded HD1080p 8-bit

BRC mode	Test System configuration	Average Decoding Speed Performance (fps) of bitstream generated by Target Usage (TU) mode				
			TU4-GAcc	TU5-GAcc	TU6-GAcc	TU7-GAcc
CQp	cfg2		418.2	432.9	435.1	432.6

\*Other names and brands may be claimed as property of others.

## Appendix B

### Summary of Quality and Performance on UHD4K 10-bit content

#### Video Quality of MSS HEVC Software Encoder on UHD4K 10-bit

BRC mode	Quality Metric for Y BD rate	Quality difference (Y BD rate %age) of Target Usage (TU) mode with respect to HM16				
		TU1	TU4	TU5	TU6	TU7
CQp	PSNR	4.4	19.8	30.2	36.5	38.8
	MS-SSIM	4.9	18.5	31.6	37.2	39.7
CBR	PSNR	7.1	23.1	27.4	41.0	43.1
	MS-SSIM	14.9	29.9	36.2	50.8	53.2
VBR	PSNR	6.9	22.8	33.5	40.7	42.7
	MS-SSIM	14.6	29.5	44.0	50.4	52.7
AVBR	PSNR	5.1	22.1	32.3	38.6	41.4
	MS-SSIM	11.4	27.2	40.1	45.1	48.8

#### Video Quality of MSS HEVC GAcc Encoder on UHD4K 10-bit

BRC mode	Quality Metric for Y BD rate	Quality difference (Y BD rate %age) of Target Usage (TU) mode with respect to HM16				
			TU4-GAcc	TU5-GAcc	TU6-GAcc	TU7-GAcc
CQp	PSNR		19.9	29.7	36.9	38.6
	MS-SSIM		18.7	31.8	38.4	40.0
CBR	PSNR		23.0	32.1	40.3	41.8
	MS-SSIM		29.3	42.5	50.5	51.8
VBR	PSNR		22.7	31.8	40.0	41.4
	MS-SSIM		28.8	42.1	50.1	51.3
AVBR	PSNR		22.0	31.1	37.9	40.3
	MS-SSIM		26.8	38.9	44.7	47.1

### Encoding Speed of MSS HEVC Software Encoder on UHD4K 10-bit

BRC mode	Test System configuration	Average Encoding Speed Performance (fps) in Target Usage (TU) mode				
		TU1	TU4	TU5	TU6	TU7
CQp	cfg3	0.7	4.2	7.7	11.6	12.4
	cfg4	1.0	5.4	10.7	15.7	16.7

### Encoding Speed of MSS HEVC GAcc Encoder on UHD4K 10-bit

BRC mode	Test System configuration	Average Encoding Speed Performance (fps) in Target Usage (TU) mode				
			TU4-GAcc	TU5-GAcc	TU6-GAcc	TU7-GAcc
CQp	cfg3		8.0	11.5	16.8	17.6
	cfg4		10.7	14.4	21.1	21.7

### Decoding Speed of Decoder on MSS HEVC Software Encoded UHD4K 10-bit

BRC mode	Test System configuration	Average Decoding Speed Performance (fps) of bitstream generated by Target Usage (TU) mode				
		TU1	TU4	TU5	TU6	TU7
CQp	cfg2	106.8	102.3	105.9	105.8	110.1

### Decoding Speed of Decoder on MSS HEVC GAcc Encoded UHD4K 10-bit

BRC mode	Test System configuration	Average Decoding Speed Performance (fps) of bitstream generated by Target Usage (TU) mode				
			TU4-GAcc	TU5-GAcc	TU6-GAcc	TU7-GAcc
CQp	cfg2		103.3	105.7	109.9	110.0

<sup>a</sup> *cfg2 (Intel® Core-i7 Processor 6700k: 4 Core, 4.0 GHz). All used configurations defined in the paper.*

<sup>@</sup> *HM16.18 runs single threaded only.*

\*Other names and brands may be claimed as property of others.